

Use & Care Guide
Manual de Uso y Cuidado
English / Español

Model/Modelo: 790.9258*

Kenmore PRO[®]

Front Control Electric Range

Estufa eléctrica a control frontal

* = color number, número de color

P/N 809126703 Rev. E

Sears Brands Management Corporation
Hoffman Estates, IL 60179 U.S.A.
www.kenmore.com



Table of Contents

KENMORE PRO LIMITED WARRANTY	2	Setting Broil	22
Before Setting Surface Controls	8	Setting Convection Bake	23
Using proper cookware	8	Setting Convection Roast	25
Cookware Material Types	8	Meat Probe	28
About the Ceramic Glass Cooktop	8	Setting the Sabbath Feature	30
About the Radiant Surface Elements	9	Clean	32
Element On and Hot Surface Indicator Lights	9	Care and Cleaning	34
Home Canning	10	Cleaning Various Parts of Your Appliance	34
Setting Surface Controls.....	11	Cooktop maintenance	35
Radiant Surface Element Settings	11	Cooktop Cleaning	35
Before Setting Oven Controls	15	Caring for Your Porcelain Enameled Glide Rack	37
Glide Racks	16	Replacing the Oven Light	38
Oven Controls	17	Removing and Replacing the Oven Door	39
Setting Bake	21	Before You Call	40
		Oven Baking	40
		Solutions to Common Problems	41

KENMORE PRO LIMITED WARRANTY

WITH PROOF OF SALE, the following warranty coverage applies when this appliance is correctly installed, operated and maintained according to all supplied instructions.

FOR ONE YEAR from the date of sale this appliance is warranted against defects in material or workmanship. A defective appliance will receive free repair or replacement at option of seller.

FOR TWO YEARS from the date of sale, a free replacement part will be supplied for a ceramic cooktop that fails due to thermal shock or for a ceramic cooktop heating element that is defective. After the first year from the sale date you are responsible for the labor cost of part installation.

For warranty coverage details to obtain free repair or replacement, visit the web page: www.kenmore.com/warranty

All warranty coverage applies for only 90 DAYS from the sale date if this appliance is ever used for other than private household purposes.

This warranty covers ONLY defects in material and workmanship, and will NOT pay for:

1. Cracks in a ceramic glass cooktop that are not a result of thermal shock.
2. Stains and scratches on a ceramic glass cooktop resulting from accident or improper operation or maintenance.
3. Discoloration of cooktop surfaces resulting from normal use.
4. Expendable items that can wear out from normal use, including but not limited to filters, belts, bags or screw-in base light bulbs.
5. A service technician to clean or maintain this appliance, or to instruct the user in correct appliance installation, operation and maintenance.
6. Service calls to correct appliance installation not performed by Sears authorized service agents, or to repair problems with house fuses, circuit breakers, house wiring, and plumbing or gas supply systems resulting from such installation.
7. Damage to or failure of this appliance resulting from installation not performed by Sears authorized service agents, including installation that was not in accord with electrical, gas or plumbing codes.
8. Damage to or failure of this appliance, including discoloration or surface rust, if it is not correctly operated and maintained according to all supplied instructions.
9. Damage to or failure of this appliance, including discoloration or surface rust, resulting from accident, alteration, abuse, misuse or use for other than its intended purpose.
10. Damage to or failure of this appliance, including discoloration or surface rust, caused by the use of detergents, cleaners, chemicals or utensils other than those recommended in all instructions supplied with the product.
11. Damage to or failure of parts or systems resulting from unauthorized modifications made to this appliance.
12. Service to an appliance if the model and serial plate is missing, altered, or cannot easily be determined to have the appropriate certification logo.

Disclaimer of implied warranties; limitation of remedies

Customer's sole and exclusive remedy under this limited warranty shall be product repair or replacement as provided herein. Implied warranties, including warranties of merchantability or fitness for a particular purpose, are limited to one year on the appliance and two years on a ceramic cooktop and heating elements, or the shortest period allowed by law. Seller shall not be liable for incidental or consequential damages. Some states and provinces do not allow the exclusion or limitation of incidental or consequential damages, or limitation on the duration of implied warranties of merchantability or fitness, so these exclusions or limitations may not apply to you.

This warranty applies only while this appliance is used in the United States.

This warranty gives you specific legal rights, and you may also have other rights which vary from state to state.

Sears Brands Management Corporation, Hoffman Estates, IL 60179

IMPORTANT SAFETY INSTRUCTIONS

Read all instructions before using this appliance.

Read all instructions before using this appliance.

This manual contains important safety symbols and instructions. Pay attention to these symbols and follow all instructions given.

Do not attempt to install or operate your appliance until you have read the safety precautions in this manual. Safety items throughout this manual are labeled with a WARNING or CAUTION statement based on the hazard type.

DEFINITIONS

⚠ This is the safety alert symbol. It is used to alert you to potential personal injury hazards. Obey all safety messages that follow this symbol to avoid possible injury or death.

⚠ WARNING - Indicates a potentially hazardous situation which, if not avoided, may result in death or serious injury.

⚠ CAUTION - Indicates a potentially hazardous situation which, if not avoided, may result in minor or moderate injury.

Important: Indicates installation, operation, maintenance, or valuable information that is not hazard related.

⚠ WARNING Storage In or On Appliance—Flammable materials should not be stored in an oven or near surface units. This includes paper, plastic, and cloth items, such as cookbooks, plastic ware, and towels, as well as flammable liquids. Do not store explosives, such as aerosol cans, on or near the oven.

⚠ CAUTION Use dry potholders. Moist or damp potholders on hot surfaces may result in burns from steam. Do not let potholders touch hot cooking areas. Do not use towels or other bulky cloths.

⚠ WARNING

Tip Over Hazard



- A child or adult can tip the range and be killed.
- Verify the anti-tip device has been installed to floor or wall.

- Ensure the anti-tip device is re-engaged to floor or wall when the range is moved.
- Do not operate the range without the anti-tip device in place and engaged.
- Failure to follow these instructions can result in death or serious burns to children and adults.



Range

leveling leg

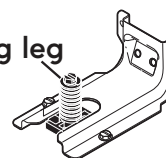

Anti-tip
bracket

To check if the anti-tip bracket is installed properly, use both arms and grasp the rear edge of the range back. Carefully attempt to tilt range forward. When properly installed, the range should not tilt forward.

Refer to the anti-tip bracket installation instructions supplied with your range for proper installation.

⚠ WARNING Do Not Leave Children Alone - Children should not be left alone or unattended in the area where appliance is in use. They should never be allowed to sit or stand on any part of the appliance, including the storage drawer, lower broiler drawer, warmer drawer, or lower double oven.

⚠ CAUTION Do not store items of interest to children in the cabinets above a range or on the backguard of the range. Children climbing on the range to reach items could be seriously injured.

IMPORTANT SAFETY INSTRUCTIONS

Read all instructions before using this appliance.

⚠ WARNING Stepping, leaning, or sitting on the door or drawers of an oven can result in serious injuries and also cause damage to the appliance. Do not allow children to climb or play around the oven. The weight of a child on an open oven door may cause the oven to tip, resulting in serious burns or other injury.

⚠ WARNING Never cover any slots, holes, or passages in the oven bottom or cover an entire oven rack with materials, such as aluminum foil. Aluminum foil linings may trap heat, causing a fire hazard.

⚠ CAUTION Wear proper apparel. Loose-fitting or hanging garments should never be worn while using this appliance. Do not let clothing or other flammable materials come into contact with hot surfaces.

⚠ CAUTION Do not heat unopened food containers. Build-up of pressure may cause container to burst and result in injury.

⚠ CAUTION When heating fat or grease, watch it closely. Grease may catch fire if it becomes too hot.

⚠ CAUTION Do not use water or flour on grease fires. Smother fire or flame or use dry chemical or foam-type extinguisher. Cover the fire with a pan lid or use baking soda.

⚠ CAUTION DO NOT TOUCH HEATING ELEMENTS OR INTERIOR SURFACES OF OVEN - Heating elements may be hot even though they are dark in color. Interior surfaces of an oven become hot enough to cause burns. During and after use, do not touch, or let clothing or other flammable materials contact heating elements or interior surfaces of oven until they have had sufficient time to cool. Other surfaces of the appliance may become hot enough to cause burns - among these surfaces are (identification of surfaces - for example, oven vent openings and surfaces near these openings, oven doors, and windows of oven doors).

⚠ CAUTION Read and follow the below instructions and precautions for unpacking, installing, and servicing your appliance:

- Remove all tape and packaging before using the oven. Destroy the carton and plastic bags after unpacking the oven. Never allow children to play with packaging material.
- Proper Installation—Be sure your appliance is properly installed and grounded by a qualified technician in accordance with the National Electrical Code ANSI/NFPA No. 70 latest edition and local electrical code requirements. In Canada, install in accordance with CSA Standard C22.1, Canadian Electrical code, Part 1, and local electrical code requirements. Install only per installation instructions provided in the literature package for this oven.
- User Servicing—Do not repair or replace any part of the appliance unless specifically recommended in the manuals. All other servicing should be done only by a qualified technician. This reduces the risk of personal injury and damage to the oven.
- Ask your dealer to recommend a qualified technician and an authorized repair service. Know how to disconnect the power to the oven at the circuit breaker or fuse box in case of an emergency.
- Do not attempt to operate the oven during a power failure. If the power fails, always turn off the oven. If the oven is not turned off and the power resumes, the oven will begin to operate again. Once the power resumes, reset the clock and oven function.
- Remove the oven door from any unused oven if it is to be stored or discarded.

Save these instructions for future reference.

IMPORTANT SAFETY INSTRUCTIONS

Read all instructions before using this appliance.

- Never modify or alter the construction of an oven by removing the leveling legs, panels, wire covers, anti-tip brackets/screws, or any other part of the oven.
- Cold temperatures can damage the electronic control. When using this appliance for the first time, or when the appliance has not been used for an extended period of time, be sure the appliance has been in temperatures above 32°F (0°C) for at least 3 hours before turning on the power to the appliance.
- Be sure to have an appropriate foam-type fire extinguisher available, visible, and easily located near the appliance.

IMPORTANT INSTRUCTIONS FOR USING YOUR OVEN

- Never use your appliance for warming or heating the room.
- Use care when opening oven door, lower oven door, or warmer drawer (some models). Stand to the side of the oven when opening the door of a hot oven. Let hot air or steam escape before you remove or replace food in the oven.
- Keep oven vent ducts unobstructed. Touching surfaces in this area when the oven is on may cause severe burns. Do not place plastic or heat-sensitive items on or near the oven vent. These items can melt or ignite.
- Placement of Oven Racks - Always place oven racks in desired location while oven is cool. If rack must be moved while oven is hot, do not let potholder contact hot heating element in oven. Use potholders and grasp the rack with both hands to reposition. Remove all bakeware and utensils before moving the rack.
- Do not use a broiler pan without its insert. Broiler pans and inserts allow dripping fat to drain away from the high heat of the broiler. Do not cover the broiler insert with

aluminum foil; exposed fat and grease could ignite.

- Protective Liners - Do not use aluminum foil to line surface unit drip bowls or oven bottoms, except as suggested in the manual. Improper installation of these liners may result in a risk of electric shock, or fire.
- Do not cook food on the oven bottom. Always cook in proper bakeware and always use the oven racks.

IMPORTANT INSTRUCTIONS FOR USING YOUR COOKTOP

- Know which knob or keypad controls each surface heating area. Place cookware with food on the cooking area before turning it on. Turn the cooking area off before removing the cookware.
- Use proper pan size. This appliance is equipped with one or more surface units of different sizes. Select cookware with flat bottoms that match the surface unit heating element. The use of undersized cookware may expose a portion of the heating element to direct contact and may result in the ignition of clothing or other items. Using the proper cookware on the cooking zone will improve efficiency.
- Utensil handles should be turned inward and not extend over adjacent surface elements — To reduce the risk of burns, ignition of flammable materials, and spillage due to unintentional contact with the utensil, the handle of the utensil should be positioned so that it is turned inward, and does not extend over adjacent surface units.
- Never leave surface elements unattended at high heat settings — Boilovers cause smoking and greasy spillovers that may ignite, or a pan that has boiled dry may melt.

Save these instructions for future reference.

IMPORTANT SAFETY INSTRUCTIONS

Read all instructions before using this appliance.

- Glazed cooking utensils — Only certain types of glass, glass/ceramic, ceramic, earthenware, or other glazed utensils are suitable for cook top service without breaking due to the sudden change in temperature. Check the manufacturer's recommendations for cook top use.
- When you are flaming foods under a ventilating hood, turn on the fan.
- Improper cookware may break due to sudden changes in temperature. Check the cookware manufacturer's recommendations for cooktop use.
- Do not use decorative surface burner covers. If an element is accidentally turned on, the decorative cover will become hot and possibly melt. Burns will occur if the hot covers are touched. Damage may also be done to the cooktop.
- Always follow the manufacturer's recommended directions for use of kitchen cleaners and aerosols. Be aware that excess residue from cleaners and aerosols may ignite causing damage and injury.
- Clean ventilating hoods frequently. Grease should not be allowed to accumulate on the hood or filter. Follow the manufacturer's instructions for cleaning hoods.

IMPORTANT INSTRUCTIONS FOR SELF-CLEANING OVENS

IMPORTANT INSTRUCTIONS FOR CERAMIC GLASS COOKTOPS

- Do not cook on a broken cooktop. If the cooktop is broken, cleaning solutions and spills may penetrate the cooktop and create a risk of electric shock. Contact a qualified technician immediately.
- Clean cooktop with caution. If a wet sponge or cloth is used to wipe spills on a hot cooking area, be careful to avoid steam burns. Some cleaners can produce noxious fumes if applied to a hot surface.

IMPORTANT INSTRUCTIONS FOR CLEANING YOUR RANGE

⚠ CAUTION Before manually cleaning any part of the oven, be sure all controls are turned off and the oven is cool. Cleaning a hot oven can cause burns.

- Clean the oven regularly to keep all parts free of grease that could catch fire. Do not allow grease to accumulate.

- Clean only the parts listed in this manual. Before using self-clean, remove the broiler pan, any food, utensils, and bakeware from the oven. Remove oven racks unless otherwise instructed.
- Do Not Use Oven Cleaners. No commercial oven cleaner or oven liner protective coating of any kind should be used in or around any part of the oven.
- Do Not Clean Door Gasket. The door gasket is essential for a good seal. Care should be taken not to rub, damage, or move the gasket.
- Some birds are extremely sensitive to the fumes given off during the self-clean cycle of any oven. Move birds to another well-ventilated room.

Important: Important Safety Notice - The California Safe Drinking Water and Toxic Enforcement Act requires the governor of California to publish a list of substances known to cause cancer, birth defects, or other reproductive harms, and it requires businesses to warn customers of potential exposures to such substances.

IMPORTANT SAFETY INSTRUCTIONS

Read all instructions before using this appliance.

GROUNDING INSTRUCTIONS

⚠ WARNING Avoid fire hazard or electrical shock. Failure to follow this warning may cause serious injury, fire, or death.

For personal safety, this appliance must be properly grounded. For maximum safety, the power cord must be plugged into an electrical outlet that is the correct voltage, is correctly polarized and properly grounded in accordance with local codes. It is the personal responsibility of the consumer to have the appropriate outlet with the correct, properly grounded wall receptacle installed by a qualified electrician. It is the responsibility and obligation of the consumer to contact a qualified installer to assure that the electrical installation is adequate and is in conformance with all local codes and ordinances.

See the installation instructions packaged with this appliance for complete installation and grounding instructions.

PRODUCT RECORD

In this space below, record the date of purchase, model, and serial number of your product. You will find the model and serial number printed on an identification plate. See [Figure 1](#) for serial plate location.

Model No. _____

Serial No. _____

Date of Purchase _____

Save sales receipt for future reference.

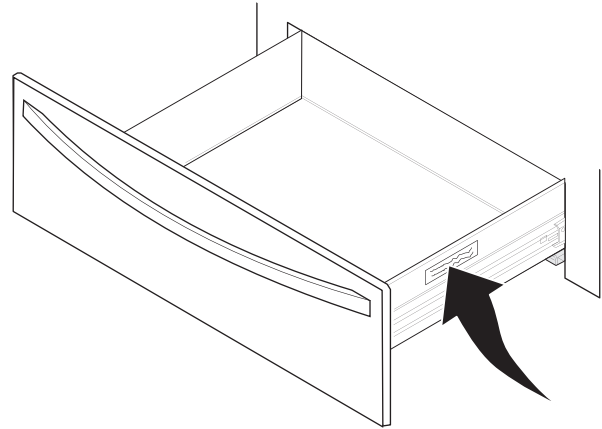

Figure 1: Serial plate location

To locate the serial plate, open the storage drawer (some models) or warmer drawer (some models). The serial plate is attached to the side.

Before Setting Surface Controls

Using proper cookware



The size and type of cookware used will influence the radiant element power level setting needed for best cooking results. Be sure to follow the recommendations for using proper cookware as illustrated in both [Figure 2](#) and [Figure 3](#).

Figure 2: Testing cookware

Check for flatness by rotating a ruler across the bottom of the cookware ([Figure 2](#)). Cookware should have flat bottoms that make good contact with the entire surface heating element ([Figure 3](#)). For detailed information about the ceramic cooktop, refer to “[Cooktop maintenance](#)” on [page 35](#).

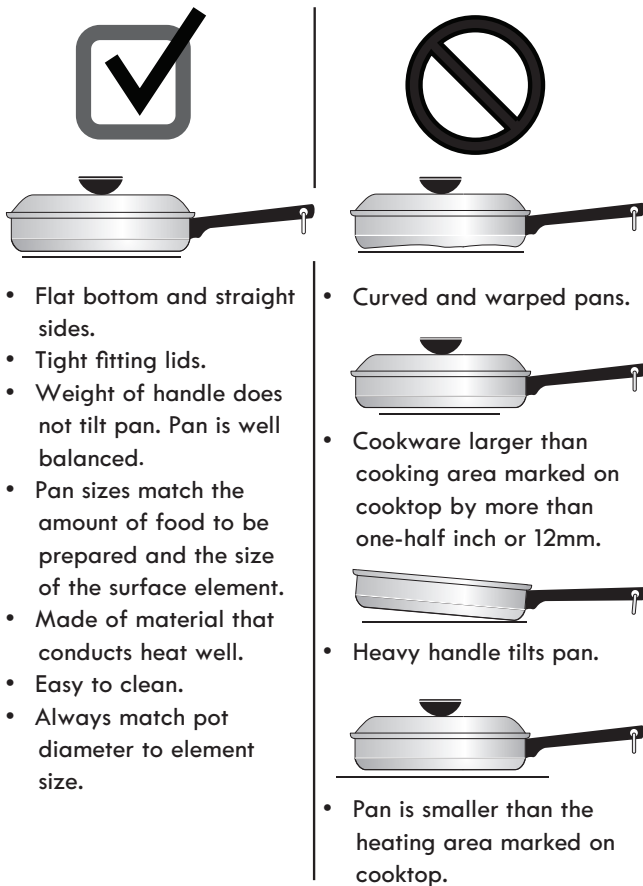

- Flat bottom and straight sides.
- Tight fitting lids.
- Weight of handle does not tilt pan. Pan is well balanced.
- Pan sizes match the amount of food to be prepared and the size of the surface element.
- Made of material that conducts heat well.
- Easy to clean.
- Always match pot diameter to element size.

- Curved and warped pans.
- Cookware larger than cooking area marked on cooktop by more than one-half inch or 12mm.
- Heavy handle tilts pan.
- Pan is smaller than the heating area marked on cooktop.

Figure 3: Proper cookware placement

Cookware Material Types

The cookware material determines how evenly and quickly heat is transferred from the surface element to the pan bottom. The most popular materials available are:

Aluminum - Excellent heat conductor. Some types of food will cause it to darken (Anodized aluminum cookware resists staining and pitting). If aluminum pans slide across the ceramic cooktop, they may leave metal marks which will resemble scratches. Remove these marks immediately.

Copper - Excellent heat conductor but discolors easily (See Aluminum).

Stainless - Slow heat conductor with uneven cooking results. Is durable, easy to clean and resists staining.

Cast Iron - A slow heat conductor however will retain heat very well. Cooks evenly once cooking temperature is reached. Not recommended for use on ceramic cooktops.

Porcelain-enamel on metal - Heating characteristics will vary depending on base material. Porcelain-enamel coating must be smooth to avoid scratching ceramic cooktops.

Glass - Slow heat conductor. Not recommended for ceramic cooktop surfaces because it may scratch the glass.

Important note:

Do not place empty aluminum, glass or porcelain-enamel coated cookware on the ceramic cooktop! The melting point of cookware made with these materials may be reached quickly especially if left empty, and they may bond to the ceramic cooktop. If the cookware melts it will damage the cooktop! Be sure to follow all the cookware manufacturer’s suggestions when using any type of cookware on the ceramic cooktop.

About the Ceramic Glass Cooktop

The ceramic cooktop has radiant surface elements located below the surface of the glass. The design of the ceramic cooktop outlines the area of the surface element underneath. Be sure to match the pan size with the diameter of the element outline on the cooktop and only flat-bottomed cookware should be used.

The type and size of cookware, the number of surface elements in use and their settings are all factors that will affect the amount of heat that will spread to areas beyond the surface elements. The areas surrounding the elements may become hot enough to cause burns.

About the Radiant Surface Elements

The element temperature rises gradually and evenly. As the temperature rises, the element will glow red. To maintain the selected setting the element will cycle on and off. The heating element retains enough heat to provide a uniform and consistent heat during the off cycle. For efficient cooking, turn off the element several minutes before cooking is complete. This will allow residual heat to complete the cooking process.

⚠ CAUTION Radiant surface elements may appear to have cooled after they have been turned off. The glass surface may still be hot and burns may occur if the glass surface is touched before it has cooled sufficiently.

⚠ CAUTION Do not place plastic items such as salt and pepper shakers, spoon holders or plastic wrappings on top of the range when it is in use. These items could melt or ignite. Potholders, towels or wooden spoons could catch fire if placed too close to the surface elements.

⚠ CAUTION Do not allow aluminum foil, empty glass/porcelain cookware or any material that can melt to make contact with the ceramic cooktop. If these items melt on the cooktop they may damage the ceramic cooktop.

⚠ CAUTION Always lift cookware before moving on the ceramic glass smoothtop. Any cookware that has rough or dirty bottoms can mark and scratch the ceramic glass surface. Always start with clean cookware.

Element On and Hot Surface Indicator Lights

Your appliance is equipped with two types of surface control indicator lights that will glow on the control panel — the Element On indicator lights and the Hot Surface indicator lights.

Each surface burner knob has its own Element On indicator light, located above the knob, and it will glow when that specific surface knob's cooking element is on. A glance at these indicator lights is an easy check to ensure that all surface controls are off.

There are two Hot Surface indicator lights, both located on the control panel. One is on the left side, and the other is on the right. Each light corresponds to the three knobs on that side of the panel. It glows whenever any of the three corresponding surface cooking areas heat up and remains on until the cooktop has cooled to a moderate level.

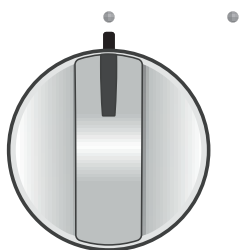

Figure 4: Control panel lights

Important notes:

- Never place or straddle a cooking utensil over two different surface cooking elements at the same time unless the utensil is designed for that purpose. This can cause uneven heating results. This can also cause the ceramic cooktop to fracture (for ceramic cooktop models only).
- Radiant elements have a limiter that allows the radiant heating element to cycle on and off, even at the HI setting. This helps to prevent damage to the ceramic smoothtop. Cycling at the HI setting is normal and will occur more often if the cookware is too small for the radiant element or if the cookware bottom is not flat.
- Be sure to read the detailed instructions for ceramic glass cooktop maintenance and cleaning in the Care & Cleaning and Before You Call checklist sections of this Use & Care Guide.

Before Setting Surface Controls

Types of Cooktop Surface Elements

Your range is equipped with several radiant surface burners, each with a unique wattage rating. The ability to heat food quicker and in larger volumes increases as the element wattage increases. The patterns on the ceramic glass will outline the size and type of element available.

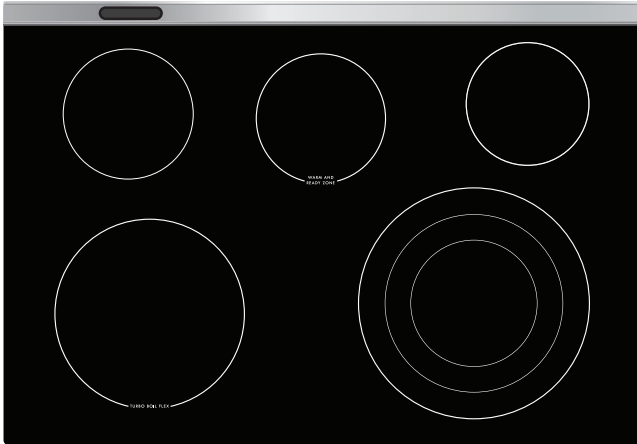

Figure 5: Surface element types

Radiant Surface Elements, by Size and Type

- Two 6-inch single radiant elements, located at the right rear and left rear positions. These elements have one round outline pattern shown on the cooktop.
- The warmer zone feature is labeled WARM AND READY ZONE and located at the center rear position of the cooktop. It uses one round outline and is designed to keep food warm only. To be used with foods already at serving temperatures.
- The 9-inch TURBO BOIL FLEX radiant element is located at the left front position.
- The 6-, 9-, 12-inch triple element is located at the right front position. It allows the user to set the smaller inner portions as a single element, both the inner and middle positions together, or the inner, middle, and outer portions to heat altogether. This triple element has two knob controls.

Important note:

For units with white glass cooktops, due to high intensity of heat generated by the surface elements, the glass surface will turn green when the element is first turned off. This phenomenon is normal and the glass will come back to its original white color after it has completely cooled down.

Home Canning

⚠ CAUTION Canning can generate large amounts of steam. Use extreme caution to prevent burns. Always raise the lid to vent steam away from you. Safe canning requires that harmful micro-organisms are destroyed and the jars are sealed completely. When canning in a water bath canner, a gentle but steady boil must be maintained continuously for the required time.

Be sure to read and observe all the following points when home canning with your appliance. Check with the USDA (United States Department of Agriculture) Web site and be sure to read all the information they have available as well as follow their recommendations for home canning procedures.

- Use only quality flat bottom canners when home canning. Use a straight-edge to check canner bottom.
- Use only a completely flat bottom canner with no ridges that radiate from the bottom center when home canning. Heat is spread more evenly when the bottom surface is flat.
- Make sure the diameter of the canner does not exceed 1 inch beyond the surface element markings or burner. It is recommended to use smaller diameter canners on electric coil and ceramic glass cooktops and to center canners on the burner grates.
- Start with hot tap water to bring water to boil more quickly.
- Use the highest heat setting when first bringing the water to a boil. Once boiling is achieved, reduce heat to lowest possible setting to maintain that boil.
- Use tested recipes and follow instructions carefully. Check with your local Cooperative Agricultural Extension Service or a manufacturer of glass jars for the latest canning information.
- It is best to can small amounts and light loads.
- Do not leave water bath or pressure canners on high heat for an extended amount of time.
- Alternate surface units between each batch to allow the units and surrounding surfaces to cool down. Try to avoid canning on the same burner unit all day.

Setting Surface Controls

Radiant Surface Element Settings

The size and type of utensil used, and the amount and type of food being cooked will influence the surface element power level setting needed for best cooking results.

The suggested settings found in [Table 1](#) are based when cooking with medium-weight aluminum pans with lids. Settings may vary when using other types of pans.

Table 1: Suggested settings for single, dual, and triple radiant surface elements

Settings	Type of cooking
High (HI)	Start most foods, bring water to a boil, pan broiling
Medium high (5 - 8)	Continue a rapid boil, fry, deep fat fry
Medium (5)	Maintain a slow boil, thicken sauces and gravies or steam vegetables
Medium Low (2 - 4)	Keep foods cooking, poach, stew
Low (LO - 2)	Keep warm, melt, simmer ¹

1. Simmer & Warm and Keep Warm settings are used to simmer and keep larger quantities of foods warm, such as stews and soups. These settings are ideal for delicate foods and melting chocolate or butter.

Important notes:

- Do not straddle cookware between two cooking surfaces unless the cookware is designed specifically for that purpose, such as a griddle.
- For efficient cooking, turn off the element several minutes before cooking is complete. This will allow residual heat to complete the cooking process.
- The surface control knobs do not have to be set exactly on a particular spot. Use the graphics provided as a guide and adjust the control knob as needed. Each surface element provides a constant amount of heat at each setting. Refer to [Table 1](#) for suggested power level settings.
- Start most cooking operations on a higher setting and then turn to a lower setting to finish cooking.
- Radiant elements have a limiter that allows the radiant heating element to cycle on and off, even at the HI setting. This helps prevent damage to the ceramic smoothtop. Cycling at the HI setting is normal and will occur more often if the cookware is too small for the radiant element or if the cookware bottom is not flat.
- A glowing red surface heating area extending beyond the bottom edge of the cookware indicates the cookware is too small for the surface heating area.

Single Radiant Surface Elements

To operate the single radiant element:

Your range is equipped with two 6-inch single radiant elements, located at the right rear and left rear positions. In addition, the 9-inch TURBO BOIL FLEX radiant element, located at the left front position, acts as a single radiant element.

⚠ CAUTION Radiant surface elements may appear to have cooled after they have been turned off. The glass surface may still be hot and burns may occur if the glass surface is touched before it has cooled sufficiently.

⚠ CAUTION Do not place plastic items such as salt and pepper shakers, spoon holders or plastic wrappings on top of the range when it is in use. These items could melt or ignite. Potholders, towels or wooden spoons could catch fire if placed too close to the surface elements.

⚠ CAUTION Do not allow aluminum foil, empty glass/porcelain cookware or any material that can melt to make contact with the ceramic cooktop. If these items melt on the cooktop they may damage the ceramic cooktop.

1. Place correctly sized cookware on single radiant surface element.
2. Push in and turn the surface element control knob in either direction to the desired setting ([Figure 7](#)). Turn the knob to adjust the setting if desired.
3. When cooking is complete, turn the radiant surface element OFF before removing the cookware.

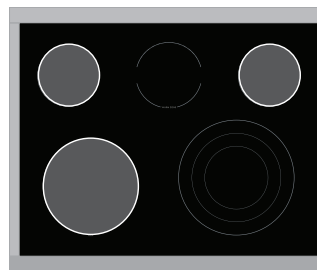

Figure 6: Location of single radiant surface elements

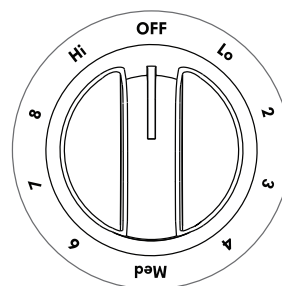

Figure 7: Single surface element control knob

Setting Surface Controls

Triple Radiant Surface Element

To operate the triple radiant element:

The triple element is located at the right front position. It may be set to heat as a 1 (single), 2 (double), or 3 (triple) element burner. This triple element has two knob controls.

⚠ CAUTION Radiant surface elements may appear to have cooled after they have been turned off. The glass surface may still be hot and burns may occur if the glass surface is touched before it has cooled sufficiently.

⚠ CAUTION Do not place plastic items such as salt and pepper shakers, spoon holders or plastic wrappings on top of the range when it is in use. These items could melt or ignite. Potholders, towels or wooden spoons could catch fire if placed too close to the surface elements.

⚠ CAUTION Do not allow aluminum foil, empty glass/porcelain cookware or any material that can melt to make contact with the ceramic cooktop. If these items melt on the cooktop they may damage the ceramic cooktop.

1. Place correctly sized cookware on the radiant surface element.
2. Push in and turn the Temperature Knob, located on the far right of the display, clockwise to begin heating the element.

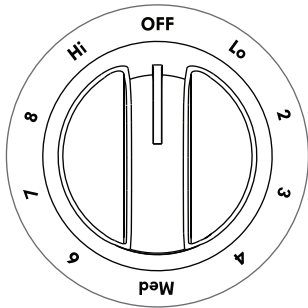

Figure 8: Temperature Knob

3. Next, turn the Triple Select Knob, located next to the Temperature Knob, clockwise to make the desired single, double, or triple burner selection.

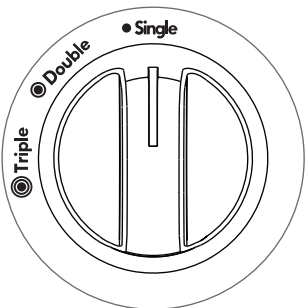

Figure 9: Triple Select Knob

Important note:

You may switch from single, double, or triple setting at any time during cooking. All three portions will adjust to the same power level, as determined by the Temperature Knob in Step 2.

4. When cooking is complete, turn both of the control knobs off before removing the cookware.

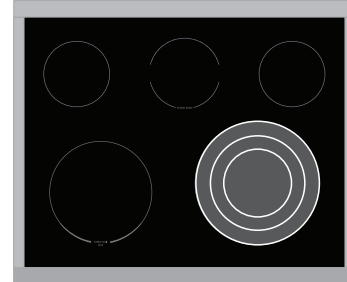

Figure 10: Triple surface element

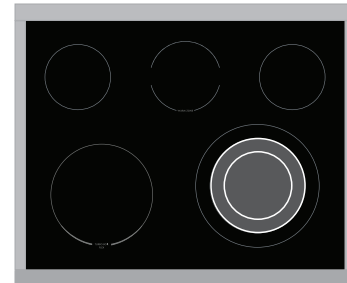

Figure 11: Double surface element

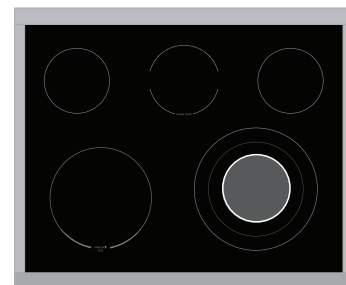

Figure 12: Single surface element

Important notes:

- For efficient cooking, turn off the element several minutes before cooking is complete. This will allow residual heat to complete the cooking process.
- The surface control knobs do not have to be set exactly on a particular spot. Use the graphics provided as a guide and adjust the control knob as needed. Each surface element provides a constant amount of heat at each setting. Refer to [Table 1](#) for suggested power level settings.
- Start most cooking operations on a higher setting and then turn to a lower setting to finish cooking.
- Radiant elements have a limiter that allows the radiant heating element to cycle on and off, even at the HI setting. This helps prevent damage to the ceramic smoothtop. Cycling at the HI setting is normal and will occur more often if the cookware is too small for the radiant element or if the cookware bottom is not flat.
- A glowing red surface heating area extending beyond the bottom edge of the cookware indicates the cookware is too small for the surface heating area.

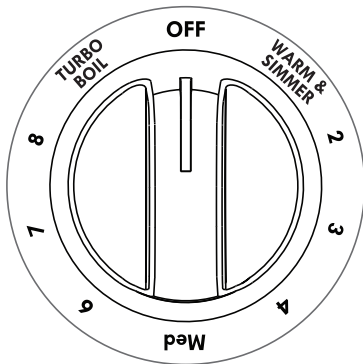

Figure 13: Turbo Boil Flex surface element control knob

Turbo Boil Flex Element

Your range is equipped with a 9-inch TURBO BOIL FLEX radiant element, located at the left front position. This higher wattage radiant element is best used when bringing larger quantities of liquid to temperature and when preparing larger quantities of food.

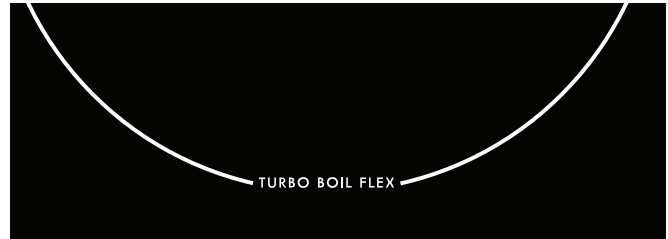

Figure 14: The Turbo Boil Flex elements

To operate the Turbo Boil Flex element:

⚠ CAUTION Radiant surface elements may appear to have cooled after they have been turned off. The glass surface may still be hot and burns may occur if the glass surface is touched before it has cooled sufficiently.

⚠ CAUTION Do not place plastic items such as salt and pepper shakers, spoon holders or plastic wrappings on top of the range when it is in use. These items could melt or ignite. Potholders, towels or wooden spoons could catch fire if placed too close to the surface elements.

⚠ CAUTION Do not allow aluminum foil, empty glass/porcelain cookware or any material that can melt to make contact with the ceramic cooktop. If these items melt on the cooktop they may damage the ceramic cooktop.

1. Place correctly sized cookware on Turbo Boil Flex radiant surface element.
2. Push in and turn the Turbo Boil Flex surface element control knob in either direction to the desired setting ([Figure 13](#)). Turn the knob to adjust the setting if desired, ranging from WARM & SIMMER to MED to TURBO BOIL.
3. When cooking is complete, turn the radiant surface element OFF before removing the cookware.

Setting Surface Controls

Warm & Ready Zone

The purpose of the warmer zone is to keep hot cooked foods at serving temperature. Use the warmer zone feature to keep cooked foods hot such as vegetables, gravies, casseroles, soups, stews, breads, pastries, and oven-safe dinner plates. Always start with hot food. Do not heat cold food with the warmer zone. All food placed on the warmer zone should be covered with a lid to maintain quality. For best results, when warming pastries or breads, the cover should have an opening to allow moisture to escape. Use only dishware, utensils and cookware recommended for oven and cooktop use on the warmer zone.

Setting warmer zone control:

⚠ WARNING Food Poisoning Hazard. Do not let food sit for more than one hour before or after cooking. Doing so can result in food poisoning or sickness. Foods that can easily spoil such as milk, eggs, fish, meat or poultry, should be chilled in the refrigerator first. Even when chilled, they should not stand in the oven for more than 1 hour before cooking begins, and should be removed promptly when finished cooking.

⚠ CAUTION Unlike other radiant surface elements, the warmer zone will not glow red when it is hot. The glass surface may still be hot and burns can occur if the glass surface is touched before it has cooled sufficiently.

⚠ CAUTION Always use potholders or oven mitts when removing food from the warmer zone as cookware and plates will be hot.

⚠ CAUTION Do not place flammable items such as plastic salt and pepper shakers, spoon holders or plastic wrappings on top of the range when it is in use. These items could melt or ignite. Potholders, towels or wooden spoons could catch fire if placed too close to the surface elements.

⚠ CAUTION Do not allow aluminum foil, empty glass/porcelain cookware or ANY material that can melt to make contact with the ceramic cooktop. If these items melt on the cooktop they may damage the ceramic cooktop.

1. Place correctly-sized cookware on the Warm & Ready Zone.
2. Turn the warmer zone control knob clockwise to the **On** position. The warmer zone uses a pre-set temperature designed to keep foods at serving temperatures (Figure 16).
3. When ready to serve, turn the warmer zone control knob to OFF position. The warmer zone will remain hot until the hot surface indicator light turns off.

Important notes:

- The warmer zone temperature level may be adjusted at any time when the warmer zone is turned on.
- Use only plates, utensils and cookware recommended for oven and ceramic cooktop use. Do not use plastic wrap or aluminum foil to cover food. Plastic or aluminum foil can melt onto the cooktop.

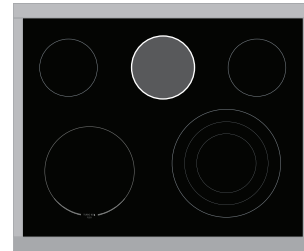

Figure 15: Warm & Ready Zone element location

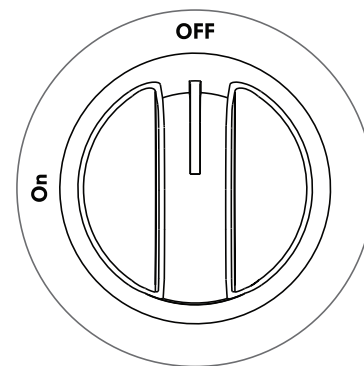

Figure 16: Warm & Ready Zone element control knob

Before Setting Oven Controls

Oven Vent Location

The oven is vented through its upper front frame. When the oven is on, warm air passes through this vent. This venting is necessary for proper air circulation in the oven and good baking results. Do not block oven vent. Steam or moisture may appear near the oven vent. This is normal.

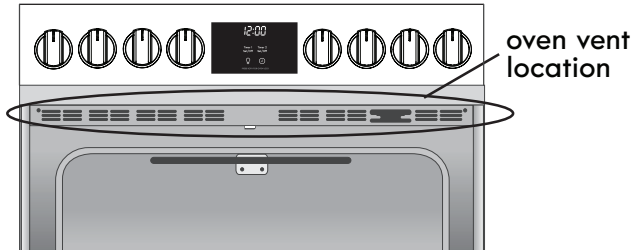

Figure 17: Oven vent location

Important: Some models are equipped with a cooling fan that runs during the cooking process and during self-clean to cool internal electronic components. It is normal for this fan to continue to run for an extended period of time, even when the appliance is off.

Oven Rack Types

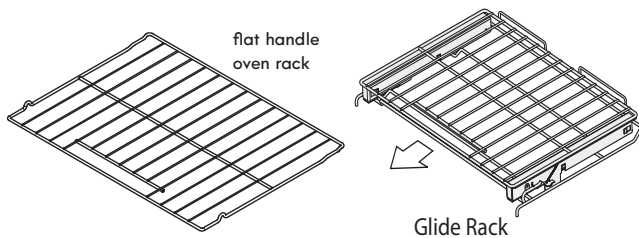

Figure 18: Oven rack types

Oven Rack Descriptions

- The range's fully-extendable oven Glide Rack allows you to check on food without removing it from the oven by effortlessly extending your food away from the oven.
- The appliance's two, flat handle oven racks may be used for most cooking needs and may be placed in most oven rack positions. It contains a handle to facilitate the sliding of the rack when it contains large amounts of food.

Important: The two, flat handle oven racks are lubricated porcelain oven racks, which can remain in the oven during the self-clean cycle. Do not clean this vegetable oil lubrication off the racks. It is important that the sides of the oven racks always have a light coating of vegetable oil. To maintain optimal rack performance, re-apply a thin layer of vegetable oil to the sides of the rack after every self-clean cycle or when the rack becomes difficult to slide.

Removing, Replacing, and Arranging Oven Racks

⚠ WARNING Protective Liners — Do not line the oven walls, racks, bottom, or any other part of the oven with aluminum foil. Doing so will alter heat distribution, produce poor baking results, and may cause permanent damage to the oven interior. During self clean temperatures, the oven will be hot enough to melt foil. Only use aluminum foil as recommended in this manual. Improper installation of these liners may result in risk of electric shock or fire.

⚠ CAUTION Always use pot holders or oven mitts when using the oven. When cooking, the oven interior and exterior, as well as the oven racks, will become very hot which can cause burns.

To Arrange: Always arrange the oven racks when the oven is cool (prior to operating the oven).

To Remove: Pull the oven rack straight forward until it reaches the stop position. Lift up front of oven rack slightly and slide out.

To Replace: Place the oven rack on the rack guides on both sides of oven walls. Tilt the front of oven rack upward slightly and slide the oven rack back into place. Be sure oven racks are level before using.

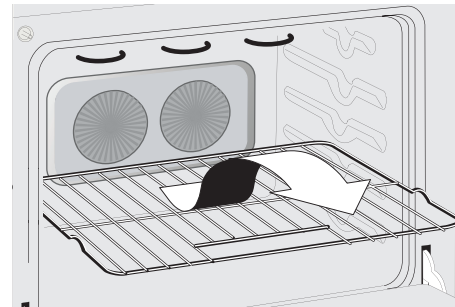

Figure 19: Removing, replacing oven racks

Air Circulation in the Oven

For best baking results allow 2-4" (5-10 cm) around the bakeware for proper air circulation and be sure pans and bakeware do not touch each other, the oven door, sides or back of the oven cavity. Hot air must be able to circulate around the bakeware in the oven for even heat to reach around the food.

Before Setting Oven Controls

Glide Racks

The fully-extendable Glide Rack is an extendable rack that makes food preparation easier. It has glide tracks that allow the rack to be pulled away from the oven without rubbing the sides of the oven wall.

Removing and Replacing the Oven Glide Racks

To remove the oven Glide Rack:

⚠ CAUTION Always use pot holders or oven mitts when using the oven. When cooking, the oven interior and exterior, as well as the oven racks, will become very hot which can cause burns.

⚠ CAUTION Always remove/replace the oven racks before turning on the oven (when the oven is cool).

1. Lift up on the release lever located across the lower front of the rack, as shown in [Figure 20](#).
2. While holding up the release lever ([Figure 21](#)), pull the Glide Rack out of the oven until the stop position is reached, use two hands if necessary.
3. Using both hands, grasp the upper and lower portions of the Glide Rack ([Figure 22](#)).
4. Lift up the front of the rack slightly and continue to pull the rack away from the oven.
5. Be sure to grasp both upper and lower rack portions together when removing or handling the Glide Rack. The rack portions move independently and are difficult to handle unless held together.

To replace the Glide Rack:

⚠ CAUTION Always use pot holders or oven mitts when using the oven. When cooking, the oven interior and exterior, as well as the oven racks, will become very hot which can cause burns.

⚠ CAUTION Always remove/replace the oven racks before turning on the oven (when the oven is cool).

1. Grasp both upper and lower portions of the Glide Rack ([Figure 22](#)).
2. Lift and hold the rack level between the oven cavity walls.
3. Tilt the front of the rack upward slightly and slide the rack completely into position. Some force may be necessary to make sure the oven rack has snapped into place.

Important: The Glide Rack is porcelain enameled and may be left in the oven to be cleaned during the self-clean cycle. After the cycle, or anytime the gliding is rough, the Glide Rack extension tracks should be treated with graphite lubrication.

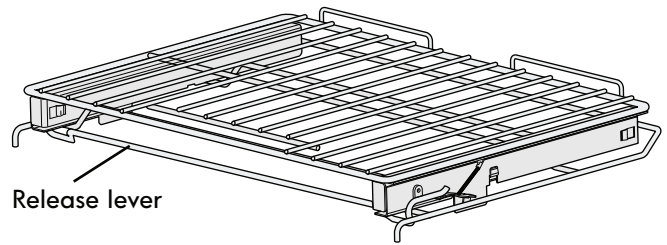

Figure 20: Extensible Glide Rack with release lever in locked position

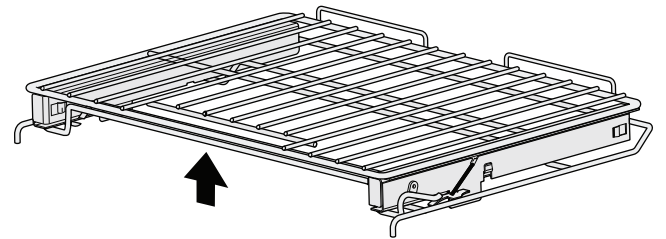

Figure 21: Extensible Glide Rack with release lever in unlocked position

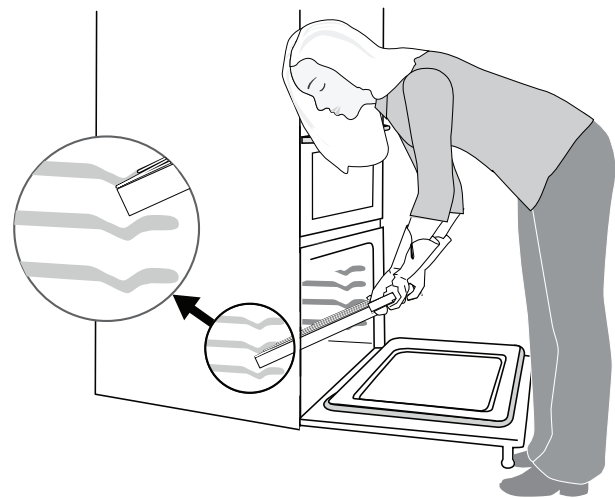

Figure 22: Removing and replacing the oven Glide Rack

Important notes:

To prevent possible damage to the oven, do not attempt to close the oven door until all the oven racks are fully positioned inside the oven cavity.

For instructions on how to best clean these oven racks, see [“Cooktop maintenance”](#) on [page 35](#).

Oven Controls



- Oven Mode Selector Knob** - Use this knob to select the desired cooking mode, such as bake, broil, and so on. This knob works hand-in-hand with the Oven Temperature Selector Knob.
- Oven Control Display** - The display serves two purposes. First, it will display a series of icons designed to tell you how the oven is operating. And second, you may press the default icons shown above to set such functions as the timers, the time of day, oven light, audio control, energy saving mode, etc.
- Oven Temperature Selector Knob** - This knob's primary function is to set the temperature. But it also works hand-in-hand with the Oven Mode Selector Knob, and some modes will not become active unless both knobs are set to same setting, such as Broil and Clean (self-clean). In addition, for Bread Proof to work, the Oven Mode Selector Knob must be set to Bake.
- Accela-Heat™** - Use the Accela-Heat™ feature to bake foods without the need for preheating.
- Warm & Hold** - Use to keep cooked food warm after cooking has finished for up to three hours.
- Bake** - Use to enter the normal baking mode temperature and start a normal bake function, at any temperature from 200°F to 550°F (93°C to 288°C).
- Conv Bake** - Use to obtain the best culinary results when baking with multiple pans and racks at any temperature from 200°F to 550°F (93°C to 288°C).
- Conv Roast** - Use to select the convection roasting function, best for cooking tender cuts of beef, lamb, pork, and poultry. Use this mode when cooking speed is desired at any temperature from 200°F to 550°F (93°C to 288°C).
- Broil** - Use to select the broil function.
- Clean** - Use to select the function that cleans the oven with high temperatures, which eliminate soils completely or reduces them to a fine powdered ash you can wipe away with a damp cloth.
- Timer 1 Set/Off & Timer 2 Set/Off** - Use to set or cancel one (or both) of the minute timers. The minute timer does not start or stop cooking.
- Light** - Use to turn oven light ON and OFF.
- Clock** - Use with slew keys to set the time of day.
- Broil/Oven Temperature Selector Knob** - In order for the Broil function to work, this knob must be set to the Broil position, in addition to the Oven Mode Selector Knob being set to Broil.
- Clean/Oven Temperature Selector Knob** - In order for the self-clean function to work, this knob must be set to the Clean position, in addition to the Oven Mode Selector Knob being set to Clean.
- Bread Proof** - Use to maintain a warm environment useful for rising yeast-leavened products. The Oven Mode Selector Knob needs to be set to Bake in order for this feature to work.
- Warm** - This feature is preset to maintain a temperature of 170°F (77°C) for keeping baked foods at serving temps until cancelled.

Oven Controls

User Preference Settings

The default (factory) settings include AUd (audible control setting), ES (energy saving), UPO (User Programmable Offset) for changing the oven temperature, and rSt (reset) for changing user preference back to default settings.

User preferences are accessed by holding the light key for 3 seconds while the oven is in the idle mode and no timers are active. Once activated, the user can make changes and scroll through the menu of options described above. Specific instructions on how to set the available user preferences can be found throughout this Oven Control section.

Minimum and Maximum Control Settings

Many of the features listed have minimum and maximum time and temperature settings that may be entered into the control.





Table 2: Minimum and maximum control settings

Feature	Min. Temp. or Time	Max. Temp. or Time
Bake	200°F (93°C)	550°F (288°C)
Accela-Heat	200°F (93°C)	550°F (288°C)
Broil	550°F (288°C)	
Timer	0:01 Hr	11 Hrs. 59 Mins.
Clean	2 Hours	4 Hours
Conv Bake	200°F (93°C)	550°F (288°C)
Conv Roast	200°F (93°C)	550°F (288°C)
Meat Probe	140°F (60°C)	210°F (99°C)
Warm & Hold	170°F (77°C)	3 hours
Bread Proof	100°F (37°C)	110°F (43°C)
Clock (12hr)	1:00 Hr	12:59 Hr

Setting The Clock

The clock key is used to access the time of day setting. When the oven is first plugged in or if there has been an interruption in power to the range, **12:00** will flash in the display.

To set the correct time of day:





1. Press the **clock** key.
2. The display will show a time along with a  and a  key in the display below.
3. Press either  or  key to scroll to the correct time of day and release the key.
4. The control will accept the new set time with a chime, and the control will show the time of day along with the two timers that are available.

Important: The clock cannot be changed when the oven is set for cooking or self clean is active. Only a 12 hour clock is available on the Kenmore Professional model.

Changing Between Continuous Bake Setting or 12 Hour Energy Saving

The oven control has a factory preset built-in 12 Hour Energy Saving feature that will turn off the oven if the oven is left on for more than 12 hours. The control may be programmed to override this feature to bake continuously.

To change between continuous bake or 12 Hour Energy Saving feature:

1. Press and hold the light key for 3 seconds until the display sounds an acceptance chime and shows one of the user preferences.
2. Press the  or  key until **ES** appears and **ON** is showing.
3. To turn the energy saving feature off, press the  or  key until **OFF** appears in the display.
4. The control will accept the change in a few seconds and sound the acceptance chime. The oven is now set for continuous cooking.

To return to the time of day display, press and hold the light key for 3 seconds until the display chimes and fades back to showing the time of day in the display. The control will return to time of day after a short time out.

Setting Control for Silent Operation



The oven is set to operate with certain chimes and tones (default settings) that alert the user to certain oven functions. The silent operation feature allows the oven control to be operated without sounds when necessary. By accessing user preferences, this option can be later returned to operate with normal programming sounds.

To set the oven control for silent operation:

1. Press and hold light for a few seconds until the display sounds an acceptance chime. **AUD** should appear in the display.



Figure 23: Silent/audio control display

2. If **AUD** is not showing, press the  key until **AUD** appears and **HI** is showing in the display. This is the normal (default) setting.
3. To turn the audible feature to a lower sound or completely **OFF**, press the  or  key until **LO** or **OFF** appears in the display.
4. When the desired setting appears in the display, release the key and wait for an acceptance chime.
5. To return to the time of day display, press and hold **Light** for 3 seconds until the display chimes and fades back to showing the time of day.

Setting Oven Lock

When the Oven Lock is set, the door is locked along with the oven controls and oven functions. If the user tries to set the oven mode or temperature mode the control will signal an error (triple beep).

To set Oven Lock:

1. Press and hold both the **light** key and **clock** key for about 3 seconds.
2. The control will beep and the motor door latch will begin to close. Do not try to open the oven door while the mechanism is locking. The door is locking/unlocking when the lock icon is flashing.



Figure 24: Press and hold Light and Clock keys

3. Once locked, a lock icon and **LOC** will appear in the display.
4. To unlock the oven door, press and hold both the **light** key and **clock** key for about 3 seconds. The lock icon will flash and the motor door lock will begin unlocking the door. Do not attempt to open the oven door while it is unlocking.
5. When the lock icon and **LOC** goes away, the door can be opened and the oven controls will be available.

Setting the Timer

The two, minute timers in the oven display serve as extra timers to help keep track of cooking functions. The timer cannot be used during a self clean cycle or if the meat probe function associated with the timer display is in use. The minimum timer setting is 1 minute and the maximum setting is 11:59.

To set the timer:

1. Press either **TIMER Set/Off** key.

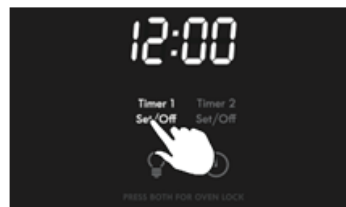

Figure 25: Setting the timer





2. The timer display will show **0:00** and the  and  keys. If the  key is pressed at this time an invalid key chime will sound.
3. Press the  key to begin to scroll to the desired setting. If the key is held, the timer value will increase rapidly. Once the desired setting is reached, release the key, press the timer key again, and the timer will start counting down automatically in a few seconds.



Figure 26: Setting the timer

4. The timer display will show the **H:M** icon if the timer is set for more than 1 minute. If the value is under 1 minute, the timer will display the time in seconds and the **H:M** icon will not appear.

Oven Controls

- When the timer ends, a reminder chime will sound and repeat once every 60 seconds for a period of five minutes. Before the user can program an expired timer again, the timer key must be pressed.
- To cancel the timer before the set time expires, press the **TIMER Set/Off** key.

The minute timers will not start or stop the cooking process. The minute timers can be used alone or while using most of the other oven features.

Operating Oven Lights

The interior oven lights will automatically turn on when the oven door is opened. The oven light will not operate during the self clean, and it will remain off.

Press  to turn the interior oven lights on and off whenever the oven door is closed.

The interior oven lights are located in the rear of the oven interior and are covered with a glass shield. The glass shield protects the bulb from high temperatures and should always be in place whenever the oven is in use. The oven light will not operate during a self clean cycle.

To replace the interior oven light, see [“Replacing the Oven Light”](#) on [page 38](#).

Important note:

For best baking results, do not leave the oven light on while cooking.

Accela-Heat

Use the Accela-Heat feature whenever you wish to start baking immediately, without the need for preheating. This feature provides good results when preparing convenience foods, such as cinnamon rolls, frozen pizza, bacon, french fries, and tater tots. Food will finish baking in the time stated in the cooking directions without the additional time ordinarily required for preheating. During Accela-Heat, the fan will pulse on and off, and the bake element will cycle on and off to maintain the set temperature for precise baking.

Bake may be set for any oven temperature between 200°F (93°C) to 550°F (288°C).

To set Accela-Heat:

⚠ CAUTION Always use pot holders or oven mitts when using the oven. When cooking, the oven interior, oven racks, and cooktop will become very hot which can cause burns.

- Remove food from packaging and arrange on a baking pan.
- Place pan in oven on rack position 3 ([Figure 27](#)) and close oven door. Accela-Heat is designed for baking on a single oven rack placed in the center of the oven.

- Turn the oven mode selector to the Accela-Heat position.
- Turn the oven temperature selector to the desired temperature. Baking will immediately begin.
- To stop baking turn oven mode knob to OFF. Also return temperature selector knob to the OFF position.

Accela-Heat best practices:

- Always place the food in the oven on rack position 3. Accela-Heat is designed for baking on a single oven rack, placed in the center of the oven.
- When using Accela-Heat, use bakeware with low or no sides. This allows the air to circulate around the food evenly.
- Food that comes in strips, such as fish sticks and chicken tenders, should be placed on the pan with the ends pointing to the sides of the oven.
- Follow the package directions for food preparation time and temperature. Accela-Heat works best when cooking foods longer than 10 minutes. If directions call for a shorter cooking time, a few extra minutes may be required for optimal cooking results.
- Do not open the oven door often. Opening the door will reduce the temperature in the oven and may increase bake time.

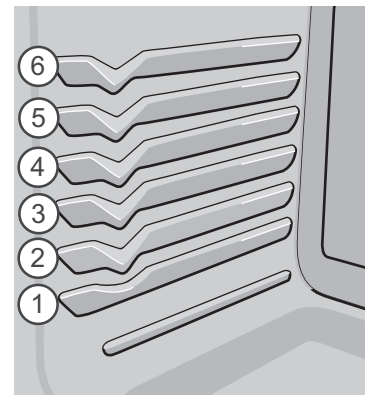

Figure 27: Oven rack positions

Setting Bake

Use the bake feature whenever the recipe calls for baking using normal temperatures. A reminder tone will sound indicating when the set bake temperature is reached and to place the food in the oven. The bake element will cycle on and off to maintain the set bake temperature for precise baking.

During preheat, the convection fan will run to help heat the oven to the set temperature. The fan will pulse on and off after the set temperature is reached.

Bake may be set for any oven temperature between 200°F (93°C) to 550°F (288°C).

To set Bake for oven temperature of 350°F (177°C):

⚠ CAUTION Always use pot holders or oven mitts when using the oven. When cooking the oven interior, oven racks, and cooktop will become very hot which can cause burns.

⚠ CAUTION Do not bake foods directly on the oven bottom. To avoid damaging the oven interior and surfaces, always bake foods in the oven using bakeware positioned on an oven rack.

1. Be sure to arrange racks to the desired positions for the item(s) to be baked.
2. Turn the oven mode selector to the **Bake** position.
3. Turn the oven temperature selector to **350°F**.
4. **PREHEAT** will begin and the oven temperature LED will turn on and sound an acceptance tone. The oven will begin heating. **PREHEATING** will appear in the display.
5. When the set temperature is reached, the **PREHEAT** light will turn off and a reminder chime will sound alerting you to place food in oven. Set either timer to keep track of actual cooking time if necessary.
6. When finished baking, be sure to return both the temperature selector knob and the oven mode knob to the **OFF** positions.

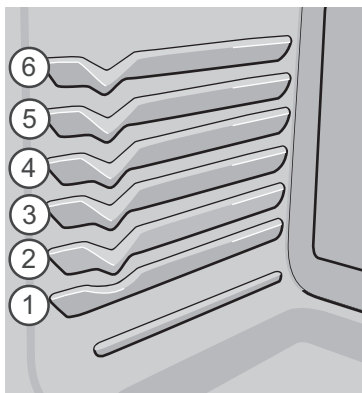

Figure 28: Oven rack positions

Important note:

If Bake is active without a cook time setting, the oven will remain on for 12 hours before turning off automatically unless it is cancelled. To bake longer than 12 hours, see [“Changing Between Continuous Bake Setting or 12 Hour Energy Saving”](#) on page 18 for instructions.

Baking Tips:

- Fully preheat the oven before baking items like cookies, biscuits and breads.
- When using any single rack, position the rack so that the food is in the center of the oven.
- Dark or dull pans absorb more heat than shiny bakeware, resulting in dark or over browning of foods. It may be necessary to reduce the oven temperature or cook time to prevent over browning of some foods. Dark pans are recommended for pies. Shiny pans are recommended for cakes, cookies, and muffins.
- For batter and dough-based baked goods such as cakes, pastries, and breads, use the convection bake function for best results.
- Convection baking is preferred for multiple rack cooking.
- For best results when baking cookies using two oven racks, place racks in positions 3 and 5 (Figure 28). Use flat rack in position 3 and Glide Rack in position 5.
- For best results when baking cakes using two oven racks, place racks in positions 1 and 4 (Figure 28) and place pans as shown in Figure 29. Use flat rack in position 1 and Glide Rack in position 4.
- When baking using two oven racks, position bakeware as shown in Figure 29. Allow at least 2 inches (5 cm) of space between bakeware for proper air circulation.
- Do not open the oven door too often. Opening the door will reduce the temperature in the oven.
- Glass bakeware is a slow heat conductor. May require reducing oven temperature.

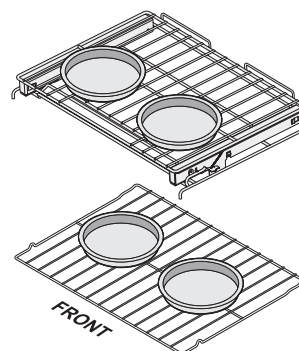

Figure 29: Baking on multiple levels/racks

Oven Controls

Setting Broil

Use the broil function to cook meats that require direct exposure to radiant heat for optimum browning results. The Broil feature is factory preset to broil at 550°F (288°C). The suggested broil settings in Table 3 are recommendations only. Depending on cooking preferences you can increase or decrease cooking times or move food to a different rack position. If the food you are broiling is not listed in Table 3, follow the instructions provided in your cookbook and watch the item closely.

To set Broil:

CAUTION Always use pot holders or oven mitts when using the oven. When cooking, the oven interior, oven racks, and cook-top will become very hot which can cause burns.

WARNING Should an oven fire occur, keep oven door closed and turn off the oven. If the fire continues, throw baking soda on the fire or use a fire extinguisher. Do not put water or flour on the fire. Flour may be explosive and water can cause a grease fire to spread and cause personal injury.

1. Position bakeware in oven to the preferred rack position (Figure 31). Close oven door.
2. Turn the oven mode selector knob to **Broil**. The indicator light will flash. Turn the temperature selector knob to **Broil**. The indicator light will turn on and remain lit. For optimum browning results, preheat oven for 2 minutes before adding food. **brl** will appear in the display.
3. Place the broiler pan on the rack. Be sure to center the broiler pan directly under the broiler element.

4. Turn the temperature and the selector knobs to **OFF** when broiling is complete or to cancel broil.

Important notes:

- Broiling is direct heat cooking and will produce smoke. If smoke is excessive, place food further away from the broil element.
- Always arrange oven racks when the oven is cool. The door must be closed for broil to operate. If the door is left open the display will show "d-O". Close the door for the function to resume. When broiling, always pull the oven rack out to the stop position before turning or removing food.
- Broiler pans and inserts allow grease to drain away from the high heat of the broiler. Do not use the pan without the insert. Do not cover the insert with foil-the exposed grease could ignite. To purchase them in the U.S.A. call 1-844-553-6667 and in Canada 1-800-469-4663 and order broil pan kit 5304442087.

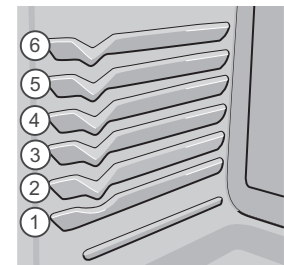
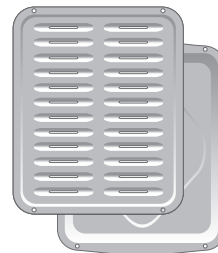

Figure 30: Broiler pan/insert Figure 31: Rack positions

Table 3: Suggested Broil Settings^{1, 2, 3}

Food	Rack Position	Cook time in minutes		Internal Temperature	Doneness
		1st side	2nd side		
Steak, 1 inch thick	5th or 6th	5	4	145°F (63°C)	Medium
Steak, 1 inch thick	5th or 6th	8	7	160°F (71°C)	Medium-well
Steak, 1 inch thick	5th or 6th	8	7	170°F (77°C)	Well
Pork Chops (3/4" thick)	5th	8	6	170°F (77°C)	Well
Chicken (bone-in)	4th	20	10	170°F (77°C)	Well
Chicken (boneless)	4th	8	6	170°F (77°C)	Well
Fish	4th	13	n/a	170°F (77°C)	Well
Shrimp	3rd	5	n/a	170°F (77°C)	Well
Hamburger, 1 inch	6th	5	4	135°F (57°C)	Rare
Hamburger, 1 inch	6th	9	7	145°F (63°C)	Medium
Hamburger, 1 inch	6th	10	8	170°F (77°C)	Well

1. The U.S. Department of Agriculture states, "Rare fresh beef is popular, but you should know that cooking it to only 140°F (60°C) means some food poisoning organisms may survive." (Source: Safe Food Book, Your Kitchen Guide, USDA Rev. June 1985.) The lowest temperature recommended by the USDA is 145°F (63°C) for medium rare fresh beef. For beef medium 160°F, well done 170°F.
2. Broiling is direct heat cooking and will produce some smoke. If smoke is excessive, place food further away from the element. Always watch food carefully to prevent burning.
3. Use the off-set or half-rack (if available) only in the top position.

Setting Convection Bake

Convection functions use a fan to circulate the oven's heat uniformly and continuously around the oven (Figure 32). This improved heat distribution allows for fast, even baking and browning results. It also gives better baking results when using two oven racks at the same time. Heated air flows around the food from all sides, sealing in juices and flavors. Breads and pastry brown more evenly. Most foods baked in a standard pan will bake faster and more evenly with the convection feature. Multiple rack baking may slightly increase bake time for some foods, but the overall result is time saved.

Convection Bake may be set for any oven temperature between 200°F (93°C) to 550°F (288°C).

Benefits of Convection Bake:

- Superior multiple oven rack performance
- Foods bake more evenly
- Foods can bake up to 25 to 30% faster.

Important note:

The convection bake feature is best used when the recipe instructions have been written especially for convection baking.

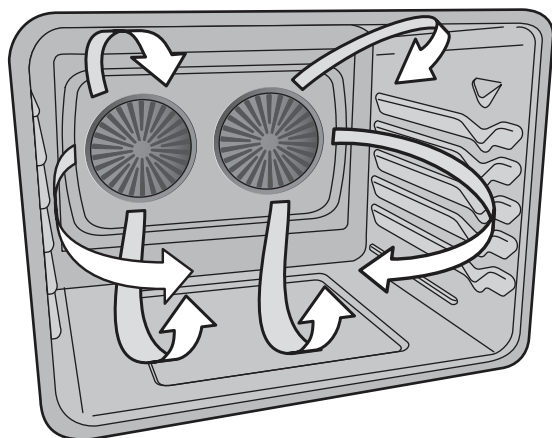

Figure 32: Air movement using convection

To set Conv Bake with a default oven set temperature of 350°F (177°C):

CAUTION Always use pot holders or oven mitts when using the oven. When cooking the oven interior, oven racks, and cooktop will become very hot which can cause burns.

CAUTION Do not bake foods directly on the oven bottom. To avoid damaging the oven interior and surfaces, always bake foods in the oven using bakeware positioned on an oven rack.

1. Arrange interior oven racks.
2. Turn the oven mode selector to **Conv Bake**.
3. Turn the oven temperature selector to **350°F**.
4. The oven temperature light will blink for a few seconds before confirming the setting. The convection fan will turn on and the oven will begin heating.
5. Once the oven reaches the set temperature the oven will sound a chime indicating the food items can be placed in the oven.
6. When finished baking, be sure to return both the temperature selector knob and the oven mode knob to the OFF positions.

Important:

- The convection fan will begin rotating once convection bake or convection roast has been activated. If the oven door is opened when the convection function is active, the convection fan will stop rotating until the oven door is closed.

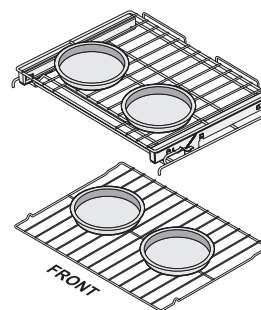

Figure 33: Convection baking on multiple levels/racks

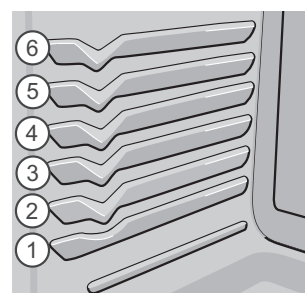

Figure 34: Oven rack positions

Oven Controls

Convection Baking Tips:

- Fully preheat the oven before baking items like cookies, biscuits, and breads.
- When using any single rack, position the rack so that the food is in the center of the oven.
- Dark or dull bakeware absorbs more heat than shiny bakeware resulting in dark or over browning of foods. It may be necessary to reduce the oven temperature or cook time to prevent over browning of some foods. Dark bakeware is recommended for pies. Shiny bakeware is recommended for cakes, cookies, and muffins.
- When using convection, use bakeware with low sides. This allows the air to circulate around the food evenly.
- Cookies should be baked on a pan with low or no sides for best results.
- Because most food items will cook faster and more evenly with the convection feature, it is advisable to reduce recipe's recommended temperature by 25° for best results. Follow the recipe's instructions using the minimum recommended cook time.
- When using convection bake, cook time reductions may vary depending on the amount and type of food being cooked.
- For batter and dough-based baked goods such as cakes, pastries, and breads, use the convection bake function for best results. Place the pans as shown in [Figure 33](#).
- Do not open the oven door often. Opening the door will reduce the temperature in the oven and may increase bake time.
- Glass bakeware may require reduced temperatures.
- For best results when baking cookies using two oven racks, place racks in positions 3 and 5 ([Figure 34](#)). Use flat rack in position 3 and glide rack in position 5.
- For best results when baking cakes using two oven racks, place racks in positions 1 and 4 ([Figure 34](#)) and place pans as shown in [Figure 33](#). Use flat rack in position 1 and glide rack in position 4.
- When baking using two oven racks, position bakeware as shown in [Figure 33](#). Allow at least 2 inches (5 cm) of space between bakeware for proper air circulation.

Setting Convection Roast

The Convection Roast function combines a cook cycle with the convection fan to roast meats and poultry. Meats cooked using the Convection Roast function will be juicier, and poultry will be crisp on the outside while staying tender and moist on the inside. Heated air circulates around the meat from all sides, gently browning the exterior and sealing in the juices and flavors. Use this mode when cooking speed is desired.

Convection Roast may be set for any oven temperature between 200°F (93°C) to 550°F (288°C).

To set Convection Roast:

⚠ CAUTION Always use pot holders or oven mitts when using the oven. When cooking, the oven interior and oven racks will become very hot which can cause burns. Do not cover the broil pan/insert with aluminum foil; the exposed grease could ignite.

⚠ WARNING Should an oven fire occur, close the oven door and turn the oven off. If the fire continues, throw baking soda on the fire or use a fire extinguisher. Do not put water or flour on fire. Flour may be explosive, and water can cause a grease fire to spread and cause personal injury.

1. Arrange oven racks. Position bakeware in oven to the preferred rack position (Figure 31). Close oven door.
2. Turn oven mode selector to **Conv Roast**.
3. Turn oven temperature selector to desired roasting temperature.
4. Turn the temperature and the selector knobs to **OFF** when broiling is complete or to cancel broil.

Important note:

- If the oven door is opened when any convection function is active, the convection fan will stop rotating until the oven door is closed.

Roasting Rack Instructions (if equipped):

When preparing meats for convection roasting, use broiler pan and insert along with the roasting rack. The broiler pan will catch grease spills and the insert will prevent grease splatters. The roasting rack will allow the heat to circulate around the meat.

1. Place the oven rack on bottom or next to the bottom oven rack position.
2. Place the insert/grid on the broiler pan. Make sure the insert is securely seated on top of the broiler pan. Do not use the broiler pan without the insert. Do not cover the insert with aluminum foil.
3. Next, place the roasting rack on the insert/grid. Make sure the roasting rack is securely seated on the grid in the broiler pan. The roasting rack allows the heated air to circulate under the food for even cooking and helps to increase browning on the underside.
4. Place meat (fat side up) on insert (Figure 35). Place prepared food on oven rack and slide into oven.

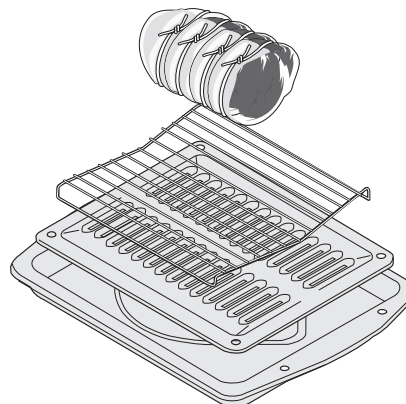

Figure 35: Meat, insert placement

Oven Controls

Table 4: Convection roasting temperature and time recommendations

Meat		Weight	Oven Temp	Internal Temp	Minutes per lb.
Beef	Standing rib roast ¹	4 to 6 lbs.	350°F (177°C)	160°F (71°C) ¹	25-30
	Ribeye roast ¹	4 to 6 lbs.	350°F (177°C)	160°F (71°C) ¹	25-30
	Tenderloin roast ¹	2 to 3 lbs.	400°F (204°C)	160°F (71°C) ¹	15-25
Poultry	Turkey whole ²	12 to 16 lbs.	325°F (163°C)	180°F (82°C)	8-10
	Turkey whole ²	16 to 20 lbs.	325°F (163°C)	180°F (82°C)	10-15
	Turkey whole ²	20 to 24 lbs.	325°F (163°C)	180°F (82°C)	12-16
	Chicken	3 to 4 lbs.	350°F-375°F (177°C-191°F)	180°F (82°C)	12-16
Pork	Ham roast, fresh	4 to 6 lbs.	325°F (163°C)	160°F (71°C)	30-40
	Shoulder blade roast	4 to 6 lbs.	325°F (163°C)	160°F (71°C)	20-30
	Loin	3 to 4 lbs.	325°F (163°C)	160°F (71°C)	20-25
	Pre-cooked ham	5 to 7 lbs.	325°F (163°C)	160°F (71°C)	30-40

- For beef, medium 160°F. Well done 170°F. The U.S. Department of Agriculture states, "Rare fresh beef is popular, but you should know that cooking it to only 140°F (60°C) means some food poisoning organisms may survive." (Source: Safe Food Book, Your Kitchen Guide, USDA Rev. June 1985.) The lowest temperature recommended by the USDA is 145°F (63°C) for medium rare fresh beef. For beef medium 160°F, well done 170°F.
- Stuffed turkey requires additional roasting time. Shield legs and breast with foil to prevent over browning and drying of the skin. Stuffing should be about 165°F.

Convection Roasting tips:

- Preheating for convection roast will not be necessary for most meats and poultry.
- Arrange oven racks so the food is in the center of the oven.
- Since convection roast cooks faster, you can reduce cook times by 25% from the recommended time of your recipe (check the food at this time). Then if needed, increase cook time until the desired doneness is obtained.
- Do not cover foods when dry roasting - covering will prevent the meat from browning properly.
- Be sure to carefully follow your recipe's temperature and time recommendations or refer to the convection roast recommendations in [Table 4](#).
- Use the broiler pan and insert, as well as the roasting rack ([Figure 35](#)) (some models). The broiler pan will catch grease spills, and the insert will help prevent splatters. The roasting rack will hold the meat.
- Do not use the broiler pan without the grid or cover the grid with aluminum foil.
- Always pull the rack out to the stop position before removing food.
- It is not recommended to roast chicken on a roasting rack. Use a deep pan instead on rack position 1.

Setting Warm

The Warm setting on the oven temperature control knob is pre-set to maintain a temperature of 170°F (77°C) for keeping baked foods at serving temperature until canceled. The feature may be used with Warm & Hold, Bake, Conv Bake, Conv Roast, and Accela-Heat.

To set Warm:

- Arrange interior oven racks and place food in oven.
- Turn the oven mode selector to **Warm & Hold, Bake, Conv Bake, Conv Roast, or Accela-Heat**.
- Set the oven temperature selector to **WARM**. The indicator light will blink and then an acceptance chime will sound.
- The preheat indicator light will turn on and stay on until the oven reaches 170°F and **HLd** appears in the display. **PREHEATING** will appear in the display.
- To cancel HLd, turn the oven mode and oven temperature controls to **OFF**.

Warm & Hold

Warm & Hold should only be used with foods that are already at serving temperatures. Warm & Hold will keep cooked foods warm and ready for serving for up to 3 hours after cooking has finished. After 3 hours the Warm & Hold will shut-off automatically. Warm & Hold will keep the oven temperature at 170° F (77°C).

To set Warm & Hold:

⚠ CAUTION Always use pot holders or oven mitts when using the oven. When cooking the oven interior, oven racks, and cooktop will become very hot which can cause burns.

⚠ WARNING Food Poisoning Hazard. Do not let food sit for more than one hour before or after cooking. Doing so can result in food poisoning or sickness. Foods that can easily spoil such as milk, eggs, fish, meat, or poultry should be chilled in the refrigerator first. Even when chilled, they should not stand in the oven for more than 1 hour before cooking begins and should be removed promptly when finished cooking.

1. If needed, arrange oven racks and place cooked food in oven.
1. Turn the oven mode control to **Warm & Hold**.
2. Turn the oven temperature control to **Warm**. The display will show **HLd** and the oven will warm to 170°F and remain at that temperature for up to 3 hours unless canceled.
3. To cancel Warm & Hold, turn both the oven mode and oven temperature controls to **OFF**.

For best results:

- Warm & Hold will maintain the oven temperature at 170° F (77°C) for 3 hours.
- Always start with hot food. Do not use the keep warm feature to heat cold food.
- Food in heat-safe glass and glass ceramic containers may need higher temperature settings compared to food in regular containers. Avoid repeated openings of the oven, it will allow hot air to escape and the food to cool.
- Aluminum foil may be used to cover food to increase moisture content.
- Avoid repeated openings of the oven. It will allow hot air to escape and the food to cool.

Bread Proof

The Bread Proof feature maintains a warm environment useful for rising yeast-leavened products. The Bread Proof feature is activated by using just the temperature control. The bread proof temperature is pre-set to warm the oven to 100°F.

Bread Proof may be set for any oven temperature between 100°F (37°C) to 110°F (43°C).

To turn on the Bread Proof feature:

1. Place dough on the oven rack and arrange oven racks on the desired position. Bake with oven door closed.
2. Turn the oven mode control to **Bake**.
3. Turn the oven temperature control to **Bread Proof**.
4. The display will show **PRF**. The control will accept the setting and **PRF** will change to show the setting of **100°F**. During this time the display will show **PREHEATING** until the oven reaches the pre-set bread proof temperature.
5. To turn off the Bread Proof feature turn both of the knobs to **OFF**.

For best results:

- No need to preheat for this feature.
- Proof bread until dough has doubled in bulk.
- Lightly cover the dough.
- Place a shallow pan with 1 to 3 cups of boiling water on the lowest rack position to keep the air moist inside the oven cavity.
- Allow at least 1" between edge of pan and walls of oven.
- Use the oven light to check progress. Do not open the oven door.

Oven Controls

Meat Probe

When cooking meat such as roasts, hams, or poultry, use the meat probe function to check the internal temperature without guesswork. For some foods, especially poultry and roasts, testing the internal temperature is the best method to insure properly cooked meats.

The following temperature settings apply to the probe function:

- Default: 170°F (77°C)
- Minimum: 140°F (60°C)
- Maximum: 210°F (99°C)

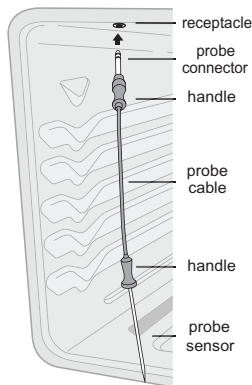

Figure 36: Probe receptacle location/insertion point

The probe receptacle is located at the top of the oven cavity as shown in [Figure 36](#).

Proper meat probe placement

Always insert meat probe so that the probe tip rests in the center of the thickest part of meat. Do not allow meat probe to touch bone, fat, gristle, or bakeware.

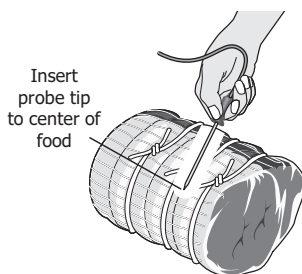

Figure 37: Proper probe placement

Tips for Probe Placement

- For bone-in ham or lamb, insert meat probe into the center of lowest large muscle or joint.
- For dishes such as meat loaf or casseroles, insert meat probe into center of food.

- When cooking fish, insert meat probe just above the gill.

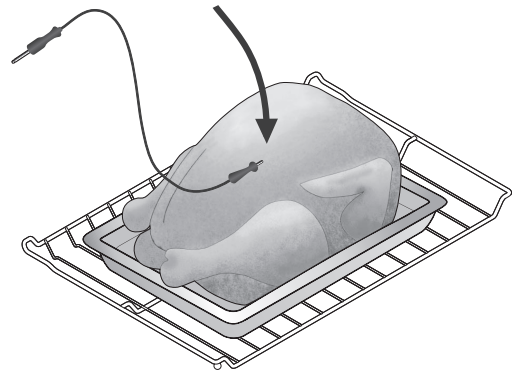

Figure 38: Proper probe placement

For whole poultry or turkey, insert meat probe as shown ([Figure 38](#)).

Easy Probe

Easy Probe allows the user to monitor the temperature of the meat while a cooking function is actively running. This feature does not cancel the cooking function when the meat probe temperature is reached. In order to activate the easy probe feature, simply insert the meat probe while an active cooking function is running. The probe temperature will immediately be shown on the display.



For best results:

- Use only the meat probe supplied with appliance. Using any other probe or device may result in damage to appliance and the meat probe receptacle.
- Never leave or store meat probe inside oven.
- Defrost food completely before inserting meat probe to avoid damaging probe.
- The probe feature must be set before setting the cooking mode and oven temperature.
- If a timer is running when the meat probe is plugged in, the control will sound a triple beep once and the timer will keep running. The timer must be canceled before the probe temperature can be set.
- If the meat probe is unplugged during cooking function, or plugged in during BROIL, the oven will stop cooking and turn off.
- When the meat probe is set correctly, the control will signal an alert when the internal food temperature reaches the desired set target temperature. When active, the internal food temperature is visible in the display during the cooking process. This eliminates any guesswork or the need to open the oven door to check the thermometer.

To set meat probe:

⚠ CAUTION Always use pot holders or oven mitts when using the oven. When cooking, the oven interior and exterior, as well as the oven racks, will become very hot which can cause burns.

⚠ CAUTION Handle the meat probe carefully when inserting and removing from food or probe receptacle. Do not use kitchen utensils, such as tongs, to pull on meat probe cable when inserting or removing from food or receptacle. Use the provided handle, as shown in Figure 36. To avoid possibility of burns after cooking, carefully unplug meat probe using a pot holder to protect hands.

1. Insert the probe into the food. Place prepared food on the desired oven rack position and slide into the oven.
2. Plug the connector end of the probe into the probe receptacle while the oven is still cool. The receptacle is located on the upper left front oven cavity wall.
3. When the probe is inserted, an acceptance tone will sound and the meat probe icon will appear in the display. Close the oven door.
4. Set oven mode control to **Accela-Heat, Bake, Conv Bake, or Conv Roast.**
5. Set oven temp control to the desired cooking temperature. The oven will begin heating.
6. The default temperature of 170°F appears in the display. Press the  key or  to set the desired probe temperature between 140°F and 210°F. Once desired temperature is set, the display will sound an acceptance chime. **Note:** The probe must be fully set before setting the oven mode and temperature mode.
7. During the cooking process, an up arrow  and the current meat probe temperature will appear in the display until the meat probe target temperature is reached. **PROBE TEMP** will appear in the display, and you will be able to watch as the meat probe temperature rises to the desired temperature.
8. When the internal temperature of the food is within 10° of the set temperature, the control will chime and a **CHECK FOOD** reminder will appear in the display.

Important note: If the meat probe temperature should exceed the maximum allowable temperature, the oven control will beep and **HOT** will appear in the display for 40 seconds to notify that the probe temperature is too high.

9. Once the target temperature of the food is reached, the control will chime to signal the end of cooking. At this time the  will turn off and the display will show the **FOOD READY** and **Hld** messages.
10. The display will continue to show the set meat probe temperature until either **Hld** ends or the meat probe is disconnected from the receptacle.

Note: If the meat probe is plugged while the oven is in a function which allows probe cooking, it may be set the following way:

1. Cancel the active cooking function by turning both the mode and temperature selectors to **OFF**. Then select the desired oven mode and oven temperature.
2. The meat probe temperature can now be set.

Table 5: USDA recommended minimal internal cooking temps

Food type	Internal temperature
Ground meat and meat mixtures	
Beef, Pork, Veal, Lamb	160°F (71°C)
Turkey, Chicken	165°F (74°C)
Fresh beef, veal, lamb	
Medium rare +	145°F (63°C)
Medium	160°F (71°C)
Well Done	170°F (77°C)
Poultry	
Chicken and Turkey, whole	165°F (74°C)
Poultry Breasts, Roasts	165°F (74°C)
Poultry Thighs, Wings	165°F (74°C)
Duck and Goose	165°F (74°C)
Stuffing (cooked alone or in bird)	165°F (74°C)
Fresh pork-roasts, steaks, and chops	
Medium	160°F (71°C)
Well Done	170°F (77°C)
Ham	
Fresh (raw)	160°F (71°C)
Pre-cooked (to reheat)	140°F (60°C)
Eggs and egg dishes	
Eggs	Cook til yolk/white firm
Egg dishes	160°F (71°C)
Leftovers and Casseroles	165°F (74°C)

The U.S. Department of Agriculture states, "Rare fresh beef is popular, but you should know that cooking it to only 140°F (60°C) means some food poisoning organisms may survive." (Source: Safe Food Book, Your Kitchen Guide, USDA Rev. June 1985.) The lowest temperature recommended by the USDA is 145°F (63°C) for medium rare fresh beef. For beef medium 160°F, well done 170°F

Visit the USDA Food Safety and Inspection website at www.fsis.usda.gov

Setting the Sabbath Feature

(for use on the Jewish Sabbath and Holidays)



For further assistance, guidelines for proper usage and a complete list of models with the Sabbath feature, please visit the web at www.star-k.org.

This appliance provides special settings for use when observing the Jewish Sabbath/Holidays. Sabbath mode disables all audible tones or visual display changes on the oven control. Bake heating is the only cooking feature available while in the Sabbath mode. Oven controls are automatically locked during Sabbath mode.

Important: The oven light will turn off during the Sabbath mode and remain off until the Sabbath mode is canceled. The meat probe feature is not available in Sabbath mode.

To set the oven for baking and activate the Sabbath feature:

⚠ WARNING Food Poisoning Hazard. Do not let food sit for more than one hour before or after cooking. Doing so can result in food poisoning or sickness. Foods that can easily spoil such as milk, eggs, fish, meat, or poultry should be chilled in the refrigerator first. Even when chilled, they should not stand in the oven for more than 1 hour before cooking begins and should be removed promptly when finished cooking.

1. Be sure the clock is set to the correct time of day. Place food in the oven.
2. Turn the oven mode selector to **Bake**.
3. Turn the oven temperature selector to the desired bake temperature.
4. An acceptance chime will sound, the oven will start heating and the LED lights will stop blinking and remain on.
5. To enter Sabbath mode press and hold the **Light** key for about 3 seconds. The control will sound an acceptance chime and **SAB** will appear in the display below the time of day.



Figure 39: Oven display showing Sabbath mode

Note: During the Sabbath mode all normal sounds of the oven control will be turned off. However the control will allow any sounds associated with alarms.

During Sabbath operation the oven temperature may be changed by adjusting the oven temperature selector. The oven will remain in Sabbath until canceled by the user.

To turn off the Sabbath feature:

1. Turning the oven mode selector and the oven temperature selector to the **OFF** position will cancel BAKE only.
2. To turn off the Sabbath feature press and hold the oven light key for about 3 seconds.
3. The acceptance chime will sound and SAB will disappear from the display. Be sure both oven selectors are returned to the OFF positions

Power failure while using Sabbath feature:

Should you experience a power failure or interruption, the oven will shut off. When power is returned, **SF** (Sabbath Failure) will be displayed, and the oven will not turn back on automatically. If your food was nearly fully cooked, you may allow the trapped heat in the oven to finish the cooking process. Otherwise, you should remove the food when the power failure occurs because you may only start the oven once during the Sabbath/Jewish holidays.

To turn off the Sabbath feature:

1. Turn the oven mode selector and the oven temperature selector to the **OFF** position.
2. Press and hold the **Light** key for at least 3 seconds. **SF** will disappear from the display, and the oven may be used with all normal functions.

Adjusting the Oven Temperature

The temperature in the oven is pre-set at the factory. When first using the oven, be sure to follow recipe times and temperatures.

Important note: Do not use oven thermometers such as those found in grocery stores to check the temperature settings inside your oven. These oven thermometers may vary as much as 20 to 40 degrees from actual temperatures.

If you think the oven is cooking too hot or too cool for the temperature you select, you can adjust the actual oven temperature to be more or less than what is displayed by accessing the UPO (User Programmable Offset).

Before adjusting, test a recipe by using a temperature setting higher or lower than the recommended temperature. The baking results should help you to decide how much of an adjustment is needed.

Important: Before making a temperature adjustment, make sure both the oven mode and oven temperature control knobs are in the OFF position.

To adjust the oven temperature:

1. When the oven is idle, press and hold **Light** for 3 seconds until the display sounds an acceptance chime. **Aud** should appear in the display.
2. Press the  key until **UPO** appears and the default setting of **0°** (or the last offset temperature) is showing.

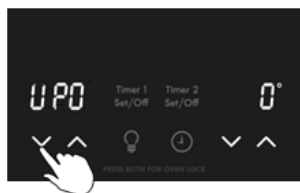



Figure 40: UPO shown at default setting

3. Press the  or  key until the desired temperature change (offset) is reached. The display will change $\pm 5^\circ$ with each key press to a maximum of **+ 35°** or a minimum of **- 35°F**.

Once the new offset appears in the display, release the key and the control will accept the change.

4. To return the display to normal, press and hold **Light** until an acceptance chime sounds. The display will return to show the time of day.

Note: Changing the UPO will not affect the broil or self clean temperatures.

Restoring Factory Default Settings

Your appliance was set with predetermined (default) oven control settings. The following options have settings that can be modified and may have been changed since the appliance was new:

- Continuous bake or 12 hour energy savings mode (ES)
- Silent or audible control (Aud)
- Oven temperature adjustments (UPO)

To rest user preferences to original factory setting:

1. Press and hold the light key for 3 seconds until the display changes to show a user preference.
2. Use the  to scroll until **rST** appears.
3. Press the arrow key on the right side of the display until **yES** appears in the display and release the key.
4. The control will accept the change and all the user preferences will return to factory settings (default).
5. To exit the user preferences, press and hold **Light** for 3 seconds and the display will return to show the time of day.

Important: Important: Choosing the **yES** reset option will return all user preferences to their default settings.

Oven Controls

Clean

A self cleaning oven cleans with very high temperatures well above normal cooking temperatures. The high temperature eliminates soils completely or reduces them to a fine powdered ash you can wipe away afterwards with a damp cloth.

The Self Clean function allows you to set a cleaning time from 2 hours to 4 hours. A 3 hour cleaning time is recommended for normal cleaning, 2 hours for light cleaning, and 4 hours for heavy cleaning.

While in clean mode, the oven heats to temperatures much higher than those used in normal cooking. Sounds of metal expansion and contraction are normal. Odors are normal as the food soil is being removed. Smoke may appear through the oven vent. If heavy spills are not wiped up before cleaning, they may flame and cause more smoke and odor than usual. This is normal and safe and should not cause alarm. If available, use an exhaust fan during the self-cleaning cycle.

Read Before Starting Self Clean:

⚠ CAUTION Do not leave small children unattended near the appliance. During the self cleaning cycle, the outside of the oven can become very hot to touch and can cause burns.

⚠ CAUTION Do not line the oven walls, racks, bottom or any other part of the oven with aluminum foil. Doing so will destroy heat distribution, produce poor baking results and cause permanent damage to the oven interior. Aluminum foil will melt to the interior of the oven.

⚠ CAUTION The health of some birds is extremely sensitive to the fumes given off during the self cleaning cycle of any oven. Move birds to another well-ventilated room.

⚠ CAUTION Do not force the door open. This can damage the automatic door locking system. Use caution when opening the oven door after self cleaning. The oven may still be very hot and can cause burns. To avoid possible burns stand to the side of the oven when opening the oven door to allow hot air or steam to escape.



Figure 41: Oven door area to clean and not clean (gasket).



Important notes:

Completely remove all oven racks and any accessories from oven cavity to avoid damage to oven racks. If the oven racks are not removed they may discolor.

- Remove all items from the oven including bakeware, utensils and any aluminum foil. Aluminum foil will not withstand high temperatures from a self clean cycle and will melt.
- Do not use oven cleaners or oven protective coatings in or around any part of the oven interior.
- Clean any soil from the oven frame, the door liner outside the oven door gasket and the small area at the front center of the oven bottom (Figure 41). These areas heat sufficiently to burn soil on. Clean using soap and water prior to starting Self Clean.
- Do not clean the oven door gasket (Figure 41). The woven material of the oven door gasket is essential for a good seal. Care should be taken not to rub, damage or remove the gasket. Do not use any cleaning materials on the oven door gasket. Doing so could cause damage to the door gasket.
- Remove any excessive build up caused by spills. Any spill on the oven bottom should be wiped up and removed before starting a self clean cycle. To clean, use hot, soapy water and a cloth. Large spill residue can cause heavy smoke or fire when subjected to high temperatures. Do not allow food spills with a high sugar or acid content (such as milk, tomatoes, sauerkraut, fruit juices or pie filling) to remain on the surface as they may leave a dull spot even after cleaning.
- This model comes with lubricated porcelain oven racks, which can remain in the oven during the self-clean cycle. Do not clean this vegetable oil lubrication off the racks. It is important that the sides of the oven racks always have a light coating of vegetable oil. To maintain optimal rack performance, re-apply a thin layer of vegetable oil to the sides of the rack after every self-clean cycle or when the rack becomes difficult to slide.
- If you are planning to use the oven directly after a self clean cycle, remember to allow time for the oven to cool down and the oven door to unlock. This normally takes about one hour. A 3 hour self clean cycle will actually take about 4 hours to complete.
- The timers do not function during a clean cycle.

To set the controls for a 3 hour cleaning cycle to start immediately and shut off automatically:

It is recommended to use a 2 hour clean cycle for light soils, a 3 hour cycle for average soils, and a 4 hour cycle for heavy soils.

1. Turn both the oven mode and oven temperature selectors to **CLEAN**. The display will show a 4 hour time (normal clean).
2. Use the  and  keys quickly to select a 2 or 4 hour time if desired. If this is not done completely, the arrow keys will vanish from the display.
3. Once the control accepts a clean time, the **REMOVE RACKS** message will blink in the display. If the door is open the **CLOSE DOOR** message will also appear. If the user does not shut the door within 3 minutes of the display showing the door open message, the control will cancel the Clean function.

Important: When the oven is set to run a self-clean cycle, the motor door lock will begin locking the oven door. Do not open the oven door while the lock motor is running or when any locking indicators or displays are showing. The oven door is completely locked in about 15 seconds.

Important: It is recommended to remove all non-porcelain oven racks from the oven during self-clean cycles, but the porcelain Glide Rack may be left in the oven if the rack is soiled. After a self-clean cycle, or anytime the gliding is rough, the glide rack should be treated with graphite lubrication.

4. After the **REMOVE RACKS** message ends the oven door will begin locking. Do not attempt to open the door while the motor door latch mechanism is locking.
5. **CLn** and the lock icon will appear in the display when the door is fully locked. The oven will start the Clean function.
6. The time left in the clean will be displayed under the **CLn** message.

When the Clean time ends:

CAUTION Do not force the oven door open when self-clean is active. This can damage the automatic door-locking system. Use caution when opening the door after self-clean is complete; the oven may still be very hot.

CAUTION The oven bake and broil elements may appear to have cooled after they have been turned off. The elements may still be hot and burns may occur if these elements are touched before they have cooled.

1. **CLn** will change to **Hot** in the display and the lock icon will remain visible. The oven door remains locked until the oven has cooled to a safe temperature and the motor door lock unlocks automatically.
2. When the temperature falls to the safe level, the display will fade out **Hot** from the timer display.
3. The display will then fade in --- (dashes) to prompt user to rotate both the oven mode and temperature selector knobs to the **OFF** position.

Care and Cleaning

Cleaning Various Parts of Your Appliance

Before cleaning any part of the oven, be sure all controls are turned off and the oven is cool. Remove spills and any heavy soiling as soon as possible. Regular cleaning will reduce the difficulty and time of major cleaning later.

Surface Type	Recommendation
Control knobs Painted body parts Painted decorative trim Aluminum, plastic, or vinyl trim	For general cleaning, use hot soapy water and a cloth. Dry with a clean cloth. For more difficult soils and build-up grease, use a soft cloth and clean with mild dish detergent and water or a 50/50 solution of vinegar and water. Follow by rinsing the area with clean water; dry and polish with a soft cloth. Glass cleaners may be used if sprayed on a soft cloth first. Do not spray liquids directly on the oven control and display area. Do not use large amounts of water on the control panel. Excess water on the control area may cause damage to the appliance. Do not use other liquid cleaners, abrasive cleaners, scouring pads, or paper towels. They will damage the finish.
Control panel Control keypad membrane Decorative trim (some models)	Before cleaning the control panel, turn all controls off and activate oven lockout (on some models). Do not use abrasive cleaners on any of these materials; they can scratch. Clean using hot, soapy water and a cloth or sponge. Be sure to squeeze excess water from cloth or sponge before wiping control panel, especially when wiping around the controls area. Excess water in or around the controls may cause damage to the appliance.
Porcelain enamel parts	Gentle scrubbing with a soapy non-abrasive scouring pad will remove most spots. Rinse with a 1:1 solution of clear water and ammonia. If necessary, cover difficult spots with an ammonia-soaked paper towel for 30 to 40 minutes. Rinse with clean water and a damp cloth, and then scrub with a soap-filled non-abrasive scouring pad. Rinse and wipe dry with a clean cloth. Do not allow food spills with high sugar or acid content (milk, tomatoes, sauerkraut, fruit juices, or pie filling) to remain on the surface; they may cause a dull spot even after cleaning.
Oven interior	Remove excessive spillovers from oven cavity bottom before starting Self Clean. Clean any soils from oven frame and door liner outside the oven door gasket. For very important cleaning precautions, be sure to read all the instructions on “Clean” on page 32 .
Porcelain coated oven racks	This model comes with lubricated porcelain oven racks, which can remain in the oven during the self-clean cycle. Do not clean this vegetable oil lubrication off the racks. It is important that the sides of the oven racks always have a light coating of vegetable oil. To maintain optimal rack performance, re-apply a thin layer of vegetable oil to the sides of the rack after every self-clean cycle or when the rack becomes difficult to slide. For instructions on how to care for your Glide Racks, see “Caring for Your Porcelain Enameled Glide Rack” on page 37 .
Oven door	Use soap and water to thoroughly clean the top, sides, and front of the oven door. Rinse well. You may use a glass cleaner on the outside glass of the oven door. Do not immerse the door in water. Do not spray or allow water or the glass cleaner to enter the door vents. Do not use oven cleaners, cleaning powders, or any harsh abrasive cleaning materials on the outside of the oven door.
Ceramic cooktop	Do not use spray oven cleaners on the cooktop. See “Cooktop Cleaning” and “Cooktop maintenance” on page 35 .
Stainless Steel (some models)	Always rub in direction of metal grain to avoid damaging. Do not use cleaners with high concentrations of chlorides or chlorine. Do not use harsh scrubbing cleaners. Polish with a lint-free cloth. Always be sure to wipe excess cleaner/polish off from the metal surface as bluish stains may occur during future oven heating that cannot be removed. Clean heavier soils with hot, soapy water and a cloth or sponge. Rinse and dry using clean water and a cloth.

Cooktop maintenance

Consistent and proper cleaning is essential to maintaining your ceramic glass cooktop.

Prior to using your cooktop for the first time, apply the recommended CookTop® Cleaning Creme to the ceramic surface (on the web visit www.sears.com for replacement cooktop cleaner, item number 40079). Buff with a non-abrasive cloth or no-scratch cleaning pad. This will make cleaning easier when soiled from cooking. The special cooktop cleaning cream leaves a protective finish on the glass to help prevent scratches and abrasions.

Sliding aluminum or copper clad bottom pans on the cooktop can cause metal markings on the cooktop surface. These marks should be removed immediately after the cooktop has cooled using the cooktop cleaning cream. Metal marks can become permanent if not removed prior to future use.

Cookware (cast iron, metal, ceramic or glass) with rough bottoms can mark or scratch the cooktop surface.

Do Not:

- Use cookware with dirt or dirt build up on bottom; replace with clean cookware before using.
- Use your cooktop as a cutting board or work surface in the kitchen.
- Cook food directly on the cooktop surface without a pan.
- Drop heavy or hard objects on the ceramic glass cooktop, they make cause it to crack.
- Slide anything metal or glass across the cooktop.

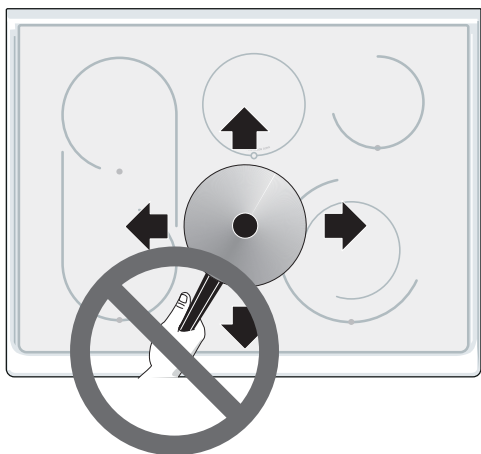

Figure 42: Do not slide pan on cooktop

Cooktop Cleaning

⚠ WARNING Do not use a cooktop cleaner on a hot cooktop. The fumes can be hazardous to your health, and can chemically damage the ceramic-glass surface.

⚠ CAUTION Before cleaning the cooktop, be sure the controls are turned to off and the cooktop is cool. The glass surface could be hot and burns may occur if the glass surface is touched before it has cooled sufficiently.

For light to moderate soil

Apply a few drops of CookTop® Cleaning Creme directly to the cooktop. Use a paper towel or use a non-abrasive plastic type no-scratch cleaning pad to clean the entire cooktop surface. Make sure the cooktop is cleaned thoroughly, leaving no residue.

For heavy, burned on soil:

Apply a few drops of CookTop® Cleaning Creme directly to the soiled area. Rub the soiled area using a non-abrasive plastic type no-scratch cleaning pad, applying pressure as needed. Do not use the pad you use to clean the cooktop for any other purpose.

If soils remain, carefully scrape soils with a metal razor blade scraper, holding scraper at a 30 degree angle to the surface. Remove loosened soils with cooktop cleaning cream and buff surface clean.

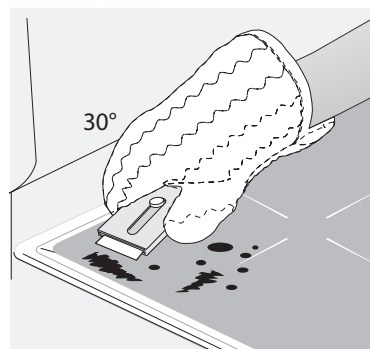

Figure 43: Cleaning with aid of razor blade

Plastic or foods with a high sugar content:

These types of soils need be removed immediately if spilled or melted onto the ceramic cooktop surface. Permanent damage (such as pitting of the cooktop surface) may occur if not removed immediately. After turning the surface elements off, use a razor blade scraper or a metal spatula with a mitt and scrape the soil from the hot surface (as illustrated). Allow the cooktop to cool, and use the same method for heavy or burned on soils.

Care and Cleaning

Cooktop cleaning (cont'd)



Figure 44: Do not use harsh cleaning chemicals

- Do not use abrasive cleaners and scouring pads, such as metal and some nylon pads. They may scratch the cooktop, making it more difficult to clean.
- Do not use harsh cleaners, such as chlorine bleach, ammonia or oven cleaners, as they may etch or discolor the cooktop.
- Do not use dirty sponges, cloths or paper towels, as they can leave soil or lint on the cooktop which can burn and cause discoloration.

Important note:

Damage to the ceramic glass cooktop may occur if you use an abrasive type cleaning pad. Only use cleaning products that have been specifically designed for ceramic glass cooktops.

Broiler Pan Cleaning Tips

To make cleaning easier, line the bottom of the broiler pan with aluminum foil. Do not cover the broiler grid with foil.

To prevent grease from baking on, remove the broiler pan from the oven as soon as cooking is completed. Use hot pads because the broiler pan is extremely hot. Pour off grease. Soak the pan in hot, soapy water.

Clean the broiler pan as soon as possible after each use. If necessary, use soap-filled steel wool pads. Heavy scouring may scratch the grid.

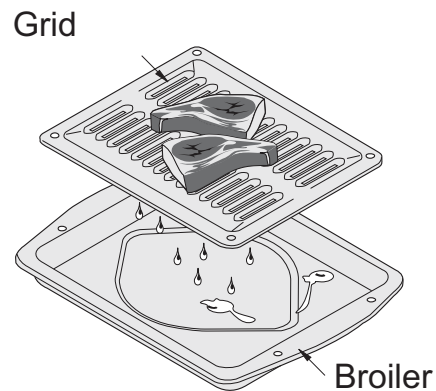

Figure 45: Broiler pan and grid

Aluminum foil and utensils

⚠ WARNING Never cover any slots, holes or passages in the oven bottom or cover an entire oven rack with materials such as aluminum foil. Aluminum foil linings may trap heat, causing a fire hazard.

Protective Liners — Do not use aluminum foil to line the oven bottom. Only use aluminum foil as recommended in this manual. Improper installation of these liners may result in risk of electric shock, or fire.

- **Aluminum foil** - Use of aluminum foil on a hot cooktop can damage the cooktop. Do not use thin aluminum cooking utensils or allow aluminum foil to touch the surface elements under ANY circumstances.
- **Aluminum utensils** - The melting point of aluminum is much lower than that of other metals. Care must be taken when aluminum pots or pans are used on the cooktop. If aluminum pans are allowed to boil dry when using the cooktop, not only will the utensil be damaged or destroyed, but it may fuse to, break or mark the ceramic glass surface, permanently damaging the cooktop surface.

Caring for Your Porcelain Enameled Glide Rack

⚠ CAUTION Handle oven racks only when they are cool. After cooking or after the self clean cycle, racks will be very hot and can cause burns.

Important Notes:

- The Glide Rack is porcelain enameled and may be left in the oven to be cleaned during the self-clean cycle. After the cycle, or anytime the gliding is rough, the glide rack extension tracks should be treated with graphite lubrication.
- Do not use cooking oil, cooking spray, or other oil-based lubrication products on the Glide Rack extension tracks. Use only the graphite lubrication in this area. To order graphite lubrication, contact your installer, servicer or dealer.
- The rack support (see step 7 image) on each side of the rack will contact the oven wall, and must always have a light coating of vegetable oil. Apply a thin layer of vegetable oil to the rack supports after every self clean cycle and when the rack becomes difficult to reposition in the oven.

To lubricate the Glide Rack:

1. Remove the rack from the oven and place the rack on a large flat surface covered with newspaper or scrap cloth. Fully extend the rack.
2. Wipe away debris and crumbs from the glide track using a cloth or sponge.

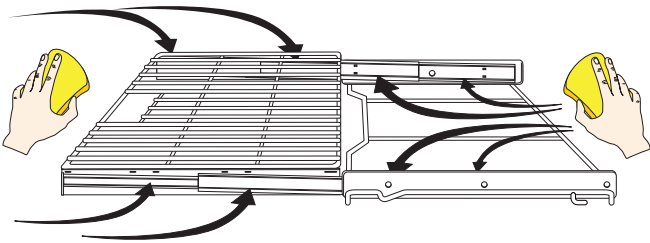

3. Shake graphite lubrication very well before applying. Place four drops of graphite lubrication along the tracks (see area circled on figure below). Repeat on both sides of the Glide Rack.

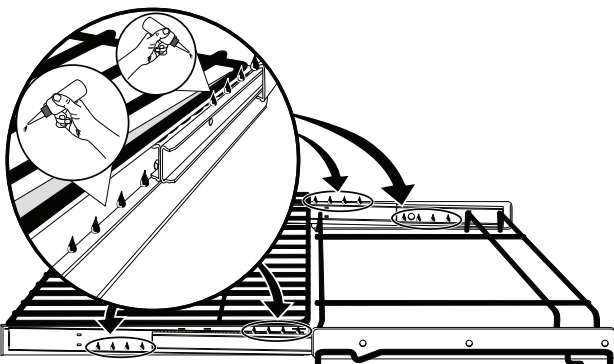

4. Extend and return the Glide Rack several times along the tracks to distribute the lubrication.

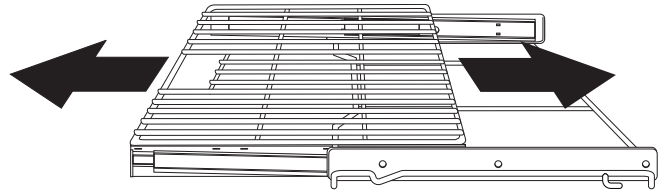

5. Turn Glide Rack over. Shake graphite lubrication very well before applying. Place four drops of graphite lubrication along the tracks. Repeat on both sides of the Glide Rack.

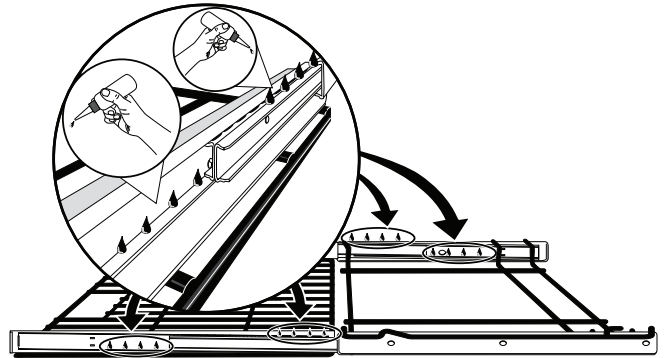

6. Extend and return the Glide Rack several times along the tracks to distribute the lubrication.

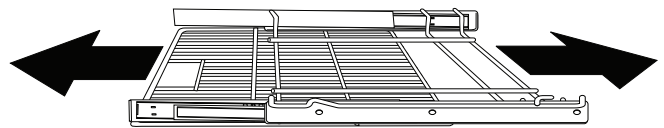

7. Apply a thin layer of vegetable oil to the rack support on each side of the Glide Rack. Keeping the rack supports lightly lubricated allows the entire rack to slide easily when changing rack positions.

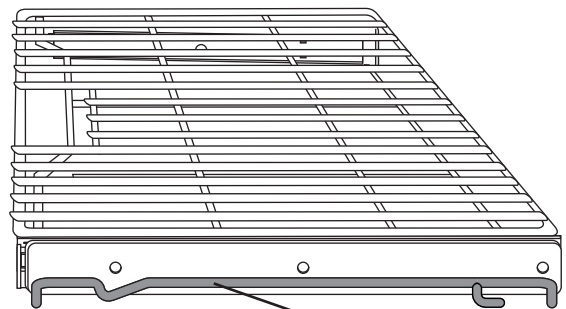

Rack Supports
Apply thin vegetable oil layer

8. Replace rack in oven right-side up.

Replacing the Oven Light

The round halogen oven light is located at the rear of the oven cavity and is covered with a glass shield held by a wire holder (Figure 46). The glass shield protects the light bulb and must be in place whenever the oven is in use.

To replace the oven interior light bulb:

⚠ CAUTION Be sure the range is unplugged and all parts are cool before replacing oven light. Wear a leather-faced glove for protection against possible broken glass.

1. Turn electrical power off at the main source.
2. Remove interior oven light shield by turning a quarter turn counter-clockwise (Figure 47).
3. Replace bulb with a new T-4 type Halogen 25 watt appliance bulb.

Important: Do not allow your fingers to touch the new bulb when replacing. This will shorten the life of the bulb. Use a paper towel or cotton glove while handling the new bulb when installing.

4. Replace glass oven light shield by rotating clockwise. The glass shield must be in place whenever the oven is in use.
5. Turn power back on again at the main source (or plug the appliance back in).
6. The clock will then need to be reset. To reset, see [“Setting The Clock”](#) on [page 18](#).

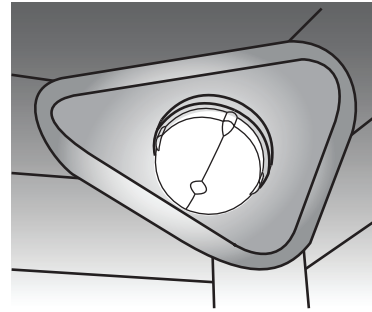

Figure 46: Oven Halogen light

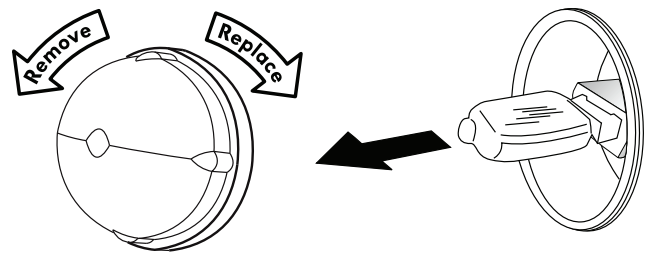

Figure 47: Replacing the oven Halogen light

Removing and Replacing the Oven Door

⚠ CAUTION To avoid possible injury when removing or replacing the oven door, follow the instructions below carefully and always hold the oven door with both hands positioned away from the door hinge area.

⚠ CAUTION The door is heavy. For safe, temporary storage, lay the door flat with the inside of the door facing down.

To remove the oven door:

1. Open oven door completely, horizontal with floor.
2. Pull up the lock located on each hinge support toward front of the oven. You may have to apply a little upward pressure on the lock to pull it up (Figure 49 and Figure 50).
3. Grasp the door by the sides, pull the bottom of the door up and toward you to disengage the hinge supports.
4. Keep pulling the bottom of the door toward you while rotating the top of the door toward the appliance to completely disengage the hinge levers (Figure 51).

To Replace Oven Door:

1. Firmly grasp both sides of oven door along the door sides. Do not use the oven door handle.
2. Holding the oven door at the same angle as the removal position, seat the hook of the hinge arm over the roller pins located on each side of the oven door frame (Figure 51). The hook of the hinge arms must be fully seated onto the roller pins.
3. Fully open the oven door, horizontal with floor (Figure 48).
4. Push the door hinge locks up toward and into the oven frame on both left and right oven door hinges to the locked position (Figure 50).
5. Close the oven door.

Special Door Care Instructions

Most oven doors contain glass that can break. Follow these recommendations:

- Do not close the oven door until all the oven racks are fully in place inside the oven cavity.
- Do not hit the glass with pots, pans, or any other object.
- Scratching, hitting, jarring, or stressing the glass may weaken its structure causing an increased risk of breakage at a later time.

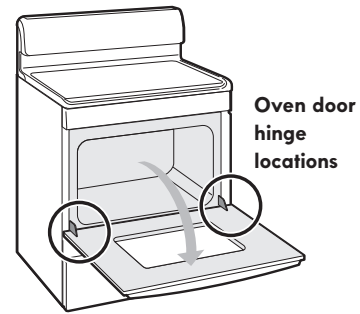

Figure 48: Door at horizontal position

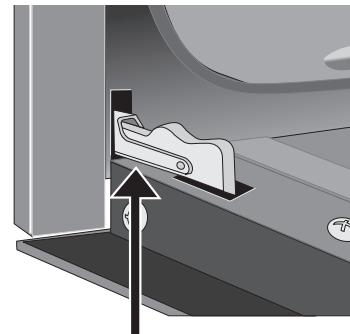

Figure 49: Door hinge locks/unlock positions

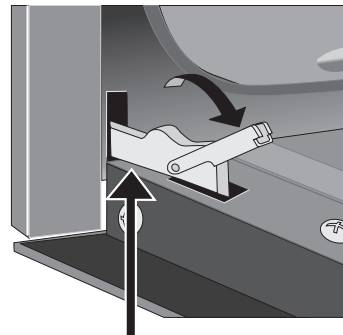

Figure 50: How to remove door

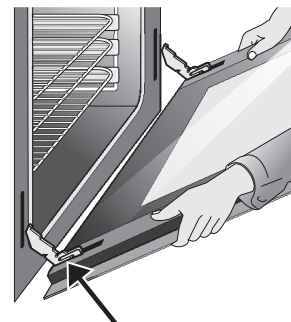

Figure 51: Hinge pin location





Before You Call

Oven Baking

For best cooking results, heat the oven before baking cookies, breads, cakes, pies or pastries, etc. There is no need to preheat the oven for roasting meat or baking casseroles.

The cooking times and temperatures needed to bake a product may vary slightly from your previously owned appliance.

Baking Problems and Solutions

Baking Problems	Causes	Corrections
<p>Cookies and biscuits burn on the bottom.</p> 	<ul style="list-style-type: none"> • Cookies and biscuits put into oven before the preheating time is completed. • Oven rack is overcrowded. • Dark pans absorb heat too fast. 	<ul style="list-style-type: none"> • Allow oven to preheat to desired temperature before placing food in oven. • Choose pan sizes that will permit 2" to 4" of air space (5.1 cm or 10.2 cm) on all sides when placed in the oven. • Use a medium weight baking sheet.
<p>Cakes too dark on top or bottom</p> 	<ul style="list-style-type: none"> • Cakes put in oven before preheating time is completed. • Rack position too high or too low. • Oven too hot. 	<ul style="list-style-type: none"> • Allow oven to preheat to the selected temperature before placing food in the oven. • Use proper rack position for baking needs. • Set oven temperature 25°F (12°C) lower than recommended.
<p>Cakes not done in center</p> 	<ul style="list-style-type: none"> • Oven too hot. • Incorrect pan size. • Pan not centered in oven. 	<ul style="list-style-type: none"> • Set oven temperature 25°F (12°C) lower than recommended. • Use pan size suggested in recipe. • Use proper rack position and place pan so there is 5.1 cm to 10.2 cm (2" to 4") of space on all sides of pan.
<p>Cakes not level.</p> 	<ul style="list-style-type: none"> • Oven not level. • Pan too close to oven wall or rack overcrowded. • Pan warped. • Oven light left on during baking. 	<ul style="list-style-type: none"> • Place a marked glass measuring cup filled with water on the center of the oven rack. If the water level is uneven, refer to the installation instructions for leveling the oven. • Be sure to allow 5.1 cm to 10.2 cm (2" to 4") of clearance on all sides of each pan in the oven. • Do not use pans that are dented or warped. • Do not leave oven light on while baking.
<p>Foods not done when cooking time is over.</p> 	<ul style="list-style-type: none"> • Oven too cool. • Oven overcrowded. • Oven door opened too frequently. 	<ul style="list-style-type: none"> • Set oven temperature 25°F (12°C) higher than suggested and bake for the recommended time. • Be sure to remove all pans from the oven except the ones to be used for baking. • Open oven door only after shortest recommended baking time.

Solutions to Common Problems

Before you call for service, review the following list. It may save you time and expense. Possible solutions are provided with the problem listed:

Problem	Solution
Poor baking results	<ul style="list-style-type: none"> Many factors effect baking results. Use proper oven rack position. Center food in the oven and space pans to allow air to circulate. Bakeware may be too lightweight or warped. Use heavier quality bakeware so foods being prepared may bake more evenly. Preheat oven to the set temperature before placing food in the oven. Try adjusting the recipe's recommended temperature or baking time. See "Adjusting the Oven Temperature" on page 31 if you feel the oven is too hot or cold.
Entire appliance does not operate.	<ul style="list-style-type: none"> Make sure power cord is plugged properly into outlet. The time of day is not set. The oven clock must first be set in order to operate the oven. Be sure oven controls are set properly. See "Setting The Clock" on page 18 and review instructions for the desired cooking function in this manual. Service wiring is not complete. For assistance call 1-844-553-6667 in the U.S.A. and 1-800-469-4663 in Canada (see back cover). Power outage. Check house lights to be sure. Call your local electric company. Short in cord/plug. Contact your dealer, installing agent, or authorized servicer to replace cord/plug. House fuse has blown or circuit breaker has tripped immediately following installation. House fuse may not be fully engaged. Check fuse and screw or engage circuit breaker securely. Call your local electric company for service outage information. For assistance call 1-844-553-6667 in the U.S.A. and 1-800-469-4663 in Canada (see back cover).
Oven light does not work.	<ul style="list-style-type: none"> Be sure the oven light is secure in the socket. See "Replacing the Oven Light" on page 38.
Flames inside oven or smoking from oven vent.	<ul style="list-style-type: none"> Excessive spills in oven. Grease or food spilled onto oven bottom or oven cavity. Wipe up excessive spills before starting oven. If flames or excessive smoke are present when using broil, see "Setting Broil" on page 22.
Self clean does not work.	<ul style="list-style-type: none"> Oven control not set properly. Make sure the oven door is closed. Make sure you have removed the oven racks and the oven rack supports from the oven. Review "Clean" on page 32.
Oven racks do not slide easily.	<ul style="list-style-type: none"> This appliance comes with lubricated porcelain oven racks, which can remain in the oven during the self-clean cycle. Do not clean this vegetable oil lubrication off the racks. It is important that the sides of the oven racks always have a light coating of vegetable oil. To maintain optimal rack performance, re-apply a thin layer of vegetable oil to the sides of the rack after every self-clean cycle or when the rack becomes difficult to slide.
Glide Rack does not slide smoothly	<ul style="list-style-type: none"> Glide Rack needs lubrication. For instructions on how to care for your Glide Rack, see "Caring for Your Porcelain Enameled Glide Rack" on page 37.
Surface element does not heat.	<ul style="list-style-type: none"> No power to the appliance. See "Entire appliance does not operate" in this table. Too low heat setting. Turn control to a slightly higher setting until element comes on. Incorrect control is on. Be sure to use correct control for the element to be used.
Warm zone element does not turn on.	<ul style="list-style-type: none"> The warm zone element will not glow when turned on. The indicator light will turn on when the warm zone element is on.

Before You Call

Surface element too hot or not hot enough.	<ul style="list-style-type: none">• Incorrect control setting. Raise or lower setting until proper amount of heat is obtained. Dial markings are an indicator of relative heat settings and will vary slightly.• Voltage is incorrect. Be sure appliance is properly connected to the power source specified in the installation instructions. If you are not sure about this requirement, call 1-844-553-6667 in the U.S.A. and 1-800-469-4663 in Canada for service (see back cover).• Lightweight or warped pans were used. Be sure to use proper cookware. Use only flat bottom, evenly balanced medium or heavyweight cookware. Heavy and medium weight pans heat evenly. Because lightweight pans heat unevenly, foods may burn easily.
Surface element turns off by itself.	<ul style="list-style-type: none">• This is normal. The element temperature rises gradually and evenly. As the temperature rises, the element will glow red. To maintain the selected setting, the element will cycle ON and OFF. The heating element retains enough heat to provide a uniform and consistent heat during the OFF cycle.
Scratches or abrasions on cooktop surface.	<ul style="list-style-type: none">• Coarse particles such as salt or sand between cooktop and utensils can cause scratches. Be sure cooktop surface and bottoms of utensils are clean before usage. Small scratches do not affect cooking and will become less visible with time.• Cleaning materials not recommended for ceramic-glass cooktop have been used. See “Cooktop Cleaning” on page 35.• Cookware with rough bottom has been used. Use smooth, flat-bottomed cookware.
Metalmarks.	<ul style="list-style-type: none">• Sliding or scraping of metal utensils on cooktop surface. Do not slide metal utensils on cooktop surface. Use a ceramic-glass cooktop cleaning cream to remove the marks. See “Cooktop maintenance” on page 35.
Brown streaks or specks.	<ul style="list-style-type: none">• Boilovers are cooked onto surface. Use razor blade scraper to remove soil. See “Cooktop maintenance” on page 35.
Areas of discoloration with metallic sheen.	<ul style="list-style-type: none">• Mineral deposits from water and food. Remove using a ceramic glass cooktop cleaning cream. Use cookware with clean, dry bottoms.
Oven smokes excessively when broiling.	<ul style="list-style-type: none">• Incorrect setting. Follow broiling instructions in the “Setting Broil” on page 22.• Meat too close to the broil element. Reposition broil rack to provide proper clearance between the meat and broil element. Remove excess fat from meat. Cut remaining fatty edges to prevent curling.• Grease build up on oven surfaces. Regular cleaning is necessary when broiling frequently. Grease or food splatters will cause excessive smoking.• Insert on broiler pan wrong side up. Grease does not drain into broiler pan. Always place the insert on the broiler pan with the ribs up and the slots down to allow grease to drip into the pan.• Broiler pan used without insert or insert cover with aluminum foil. Do not use the broiler pan without the insert or cover the insert with aluminum foil.
Convection fan does not rotate	<ul style="list-style-type: none">• Oven door is open. Convection fan will turn off if oven door is opened when convection is active. Close oven door.
Oven control panel beeps and displays an F code error.	<ul style="list-style-type: none">• Oven control has detected a fault or error condition. Press STOP/CLEAR to clear the error code. Try bake or broil function. If the F code error repeats, turn off power to appliance, wait 5 minutes and then repower appliance. Set clock with correct time of day. Try bake or broil function again. If fault recurs, press STOP to clear and call 1-844-553-6667 in the U.S.A. and 1-800-469-4663 in Canada for assistance (see back cover).

Soil not completely removed after self clean.	<ul style="list-style-type: none"> • Self Clean was interrupted. Review “Clean” on page 32. • Excessive spills on oven bottom. Clean before starting self clean. • Failure to clean soil from the oven frame, the door liner outside the oven door gasket, and the small area at the front center of the oven bottom. These areas are not in the self-cleaning area, but they get hot enough to burn on residue. Clean these areas before starting the self-cleaning cycle. Burned-on residue can be cleaned with a stiff nylon brush and water or a nylon scrubber. Be careful not to damage the oven gasket.
Appliance is not level.	<ul style="list-style-type: none"> • Poor installation. Place oven rack in center of oven. Place a level on the oven rack. • Be sure floor is level, strong, and stable enough to adequately support range. • If floor is sagging or sloping, contact a carpenter to correct the situation. • Kitchen cabinet alignment may make oven appear not level. Be sure cabinets are square and have sufficient room for appliance clearance. Cabinets not square or are built in too tightly. Contact builder or installer to make appliance accessible.
Fan noise occurring after the oven is turned off.	<ul style="list-style-type: none"> • Some models are equipped with a cooling fan that runs during the cooking process to cool internal electronic components. It is normal for this fan to continue to run for an extended period of time, even when the oven is off.
“d-O” is displayed	<ul style="list-style-type: none"> • The door was left open and control set for self-cleaning cycle. Close the door and press STOP.
Cannot move appliance easily. Appliance must be accessible for service.	<ul style="list-style-type: none"> • Cabinets not square or are built in too tightly. Contact builder or installer to make appliance accessible. • Carpet interferes with appliance. Provide sufficient space so appliance can be lifted over carpet.
Accela-Heat performs poorly	<ul style="list-style-type: none"> • Accela-Heat not used correctly. This cooking function is intended for convenience, pre-cooked, and other specific foods. See “Accela-Heat” on page 20 and follow best practices.

Before You Call

Master Protection Agreements

Congratulations on making a smart purchase. Your new Kenmore® product is designed and manufactured for years of dependable operation. But like all products, it may require preventive maintenance or repair from time to time. That's when having a Master Protection Agreement can save you money and aggravation.

The Master Protection Agreement also helps extend the life of your new product. Here's what the Agreement* includes:

- ☑ **Parts and labor** needed to help keep products operating properly **under normal use**, not just defects. Our coverage goes **well beyond the product warranty**. No deductibles, no functional failure excluded from coverage – **real protection**.
- ☑ **Expert service** by a force of more than **10,000 authorized Sears service technicians**, which means someone you can trust will be working on your product.
- ☑ **Unlimited service calls and nationwide service**, as often as you want us, whenever you want us.
- ☑ **"No-lemon" guarantee** – replacement of your covered product if four or more product failures occur within twelve months.
- ☑ **Product replacement** if your covered product can't be fixed.
- ☑ **Annual Preventive Maintenance Check** at your request – no extra charge.
- ☑ **Fast help by phone** – we call it **Rapid Resolution** – phone support from a Sears representative on all products. Think of us as a "talking owner's manual".
- ☑ **Power surge protection** against electrical damage due to power fluctuations.
- ☑ **\$250 Food Loss Protection** annually for any food spoilage that is the result of mechanical failure of any covered refrigerator or freezer.
- ☑ **Rental reimbursement** if repair of your covered product takes longer than promised.
- ☑ **25% discount** off the regular price of any non-covered repair service and related installed parts.

Once you purchase the Agreement, a simple phone call is all that it takes for you to schedule service. You can call anytime day or night, or schedule a service appointment online.

The Master Protection Agreement is a risk free purchase. If you cancel for any reason during the product warranty period, we will provide a full refund. Or, a prorated refund anytime after the product warranty period expires. Purchase your Master Protection Agreement today!

Some limitations and exclusions apply. For prices and additional information in the U.S.A. call 1-800-827-6655.

*** Coverage in Canada varies on some items. For full details call Sears Canada at 1-800-361-6665.**

Sears Installation Service

For Sears professional installation of home appliances, garage door openers, water heaters, and other major home items, in the U.S.A. call **1-844-553-6667**, and in Canada call **1-800-469-4663**.

Acuerdos maestros de protección

Enhorabuena por haber hecho una compra inteligente. Su nuevo producto Kenmore® está diseñado y fabricado para brindarle años de funcionamiento fiable. Pero, como cualquier producto, puede necesitar mantenimiento preventivo o reparaciones periódicas. Es por eso que tener un Acuerdo maestro de protección podría ahorrarle dinero y molestias.

El Acuerdo maestro de protección también sirve para prolongar la durabilidad de su nuevo producto. El acuerdo* incluye lo siguiente:

- ☑ **Piezas y mano de obra** necesarias para contribuir a mantener el funcionamiento adecuado de los productos **utilizados en condiciones normales de uso**, no sólo en caso de defectos de los productos. Nuestra cobertura va **mucho más allá que la garantía del producto**. No se aplican deducibles ni exclusiones por fallas del funcionamiento: es decir, **verdadera protección**.
- ☑ **Servicio técnico por expertos** (más de **10000 técnicos autorizados de Sears**), lo cual significa que quien repare o realice el mantenimiento de su producto será un profesional de confianza.
- ☑ **Servicio técnico a escala nacional y número ilimitado de llamadas de solicitud de servicio técnico**: se puede poner en contacto con nosotros cuantas veces lo desee y cuando lo desee.
- ☑ **Garantía "sin sorpresas"**: se reemplaza el producto cubierto por el acuerdo si ocurren cuatro o más fallas del producto en un periodo de 12 meses.
- ☑ **Reemplazo del producto**: en caso de que no se pueda reparar el producto cubierto por el acuerdo.
- ☑ **Revisión anual preventiva de mantenimiento del producto**: puede solicitarla en cualquier momento, sin costo alguno.
- ☑ **Rápida asistencia telefónica**, la cual denominamos **Solución rápida**: es decir, asistencia telefónica a través de cualquiera de nuestros representantes de Sears, sobre cualquiera de nuestros productos. Piense en nosotros como en un "manual parlante del usuario".
- ☑ **Protección contra fallas eléctricas**, contra daños debidos a fluctuaciones de la corriente eléctrica.
- ☑ **\$250 al año para cubrir cualquier posible deterioro de alimentos** que haya tenido que desechar debido a una falla mecánica de cualquiera de nuestros refrigeradores o congeladores cubiertos por este acuerdo.
- ☑ **Devolución de gastos de alquiler de electrodomésticos** si la reparación de su producto asegurado toma más que el tiempo prometido.
- ☑ **25% de descuento** aplicable tanto a los costos del servicio de reparación, como de las piezas instaladas relacionadas que no hayan quedado cubiertos por este acuerdo.

Una vez que haya realizado el pago de este acuerdo, bastará una simple llamada telefónica para concertar una visita de servicio. Puede llamar a cualquier hora del día o de la noche, o bien concertar una visita de servicio por Internet.

La adquisición del Acuerdo maestro de protección es una inversión exenta de riesgos. Si por cualquier motivo decide cancelar dicho acuerdo durante el periodo de garantía del producto, le haremos un reintegro total del valor. O bien un importe proporcional si cancela el acuerdo en cualquier otro momento posterior al vencimiento del periodo de garantía del producto. ¡Adquiera hoy mismo su Acuerdo maestro de protección!

Algunas limitaciones y exclusiones podrían aplicarse. Para solicitar precios e información adicional, llame al 1-800-827-6655 (en los EE.UU.).

*** La cobertura en Canadá varía en el caso de algunos artículos. Para obtener detalles completos al respecto, llame al 1-800-361-6665 de Sears de Canadá.**

Servicio de instalación de Sears

Para solicitar la instalación por profesionales de Sears de electrodomésticos, abridores de puertas de garaje, calentadores de agua y otros artículos de uso prioritario en el hogar, llame al **1-800-553-6667** en los EE.UU. o llame al **1-800-469-4663** en Canadá.

Kenmore®

For Sears Home Services in-home repair
of all Kenmore major appliances.

For the replacement parts, accessories and
Use & Care Guides that you need to do-it-yourself.

For professional installation of major home appliances
and items like air conditioners and water heaters.

1-844-553-6667

www.kenmore.com

In Canada 1-800-469-4663

www.sears.ca

Call anytime for the location of your nearest
Sears Parts & Repair Service Center

1-800-488-1222 (U.S.A.)

1-800-469-4663 (Canada)

To purchase a protection agreement on a serviceable product :

1-800-827-6655 (U.S.A.)

1-800-361-6665 (Canada)

Para pedir servicio de reparación
a domicilio, y ordenar piezas:

1-888-SU-HOGAR®

(1-888-784-6427)

www.kenmore.com

Au Canada pour service en français:

1-800-LE-FOYER^{MC}

(1-800-533-6937)

www.sears.ca

